

SVEUČILIŠTE U ZAGREBU
GRAĐEVINSKI FAKULTET

MIRIJANA PRŠA, MATEA REBRINA, IVANA SREDNOSELEC

**ANALIZA GEOMETRIJSKIH KARAKTERISTIKA RIBLJIH
STAZA U OVISNOSTI O HIDRAULIČKIM UVJETIMA
TEČENJA**

ZAGREB, 2013

Ovaj rad je izrađen u Zavodu za hidrotehniku Građevinskog fakulteta Sveučilišta u Zagrebu pod vodstvom doc.dr.sc. Eve Ocvirk i predan je za natječaj za dodjelu Rektorove nagrade u akademskoj godini 2012./2013.

SADRŽAJ

1. UVOD.....	1
2. STANJE PODRUČJA.....	2
2.1. KORIŠTENJE VODNIH SNAGA	2
2.1.1. ANALIZA ISKORISTIVOG VODNOG POTENCIJALA U RH.....	3
2.2. SLATKOVODNE RIBLJE VRSTE U HRVATSKOJ.....	4
3. RIBLJE STAZE	5
3.1. VAŽNOST RIBLJIH STAZA	6
3.2. TIPOVI RIBLJIH STAZA.....	7
3.2.1. TEHNIČKE RIBLJE STAZE	8
3.2.1.1. STAZE S BAZENIMA.....	8
3.2.1.2. STAZE S VERTIKALNIM PROREZIMA.....	8
3.2.1.3. DENILOVE STAZE.....	9
3.2.1.4. KANALI UMJETNO POVEĆANE HRAPAVOSTI	10
3.2.2. PRIRODNE RIBLJE STAZE	11
3.2.3. RIBLJI LIFTOVI.....	12
3.3. OBLIKOVANJE ULAZA I IZLAZA IZ RIBLJIH STAZA.....	13
3.4. OBLIKOVANJE DNA.....	15
4. HIDRAULIČKO OBLIKOVANJE RIBLJIH STAZA.....	16
4.1. PRORAČUN RIBLJIH STAZA S NORMALNIM NAIZMJENIČNO POSTAVLJENIM REBRIMA.....	17
4.2. PRORAČUN RIBLJIH STAZA S BAZENIMA	20
4.3. PRORAČUN PRIRODNIH RIBLJIH STAZA.....	23
4.4. ANALIZA GEOMETRIJSKIH KARAKTERISTIKA RIBLJIH STAZA.....	35
4.4.1. RIBLJE STAZE S NORMALNIM NAIZMJENIČNIM REBRA	35
4.4.2. RIBLJE STAZE S BAZENIMA	39
4.4.3. PRIRODNE RIBLJE STAZE	41
5. RASPRAVA REZULTATA	43
6. ZAKLJUČAK	45
7. LITERATURA.....	46
8. SAŽETAK.....	48
9. SUMMARY.....	49
10. PRILOZI.....	50

1. UVOD

Trenutno je u svijetu, čiji se broj stanovnika znatno povećava, a količina neobnovljivih izvora energije rapidno smanjuje, naglašen interes za obnovljivim izvorima energije. Među takvim izvorima energije ističu se hidroelektrane. S druge strane društvo je sve svjesnije problema održivosti postojećeg ekosustava. Zbog toga se pri izboru tipa hidroelektrane prednost daje malim hidroelektranama. Tako se i Hrvatska, kao pristupnica EU obvezala do 2020. godine izgraditi barem 100 MW malih hidroelektrana. Male hidroelektrane osim na migracije riba praktično i nemaju nekih značajnijih utjecaja na prirodu. Problem migracije ribljih vrsta rješavaju riblje staze - konstrukcije koje omogućuju uzvodnu i nizvodnu migraciju ribljih vrsta i drugih organizama koji nastanjuju vodotoke.

U ovom radu dane su osnove oblikovanja i proračuna tri tipa ribljih staza za koje je procijenjeno da najbolje odgovaraju hrvatskim slatkovodnim ribljim vrstama. Kriteriji pri odabiru tipova ribljih staza bili su da pregrade u ribljoj stazi budu postavljene tako da riblje vrste ne moraju preskakati prepreke već da prepreke potiču njihovo vijugavo plivanje, kakvo je karakteristično za većinu hrvatskih slatkovodnih ribljih vrsta. Odabrana su 2 tipa tehničkih staza i za usporedbu riblja staza koja imitira prirodni vodotok. Od tipova tehničkih staza izabrane su riblje staze s normalnim naizmjenično postavljenim rebrima i riblje staze sa bazenima. Izrađeni su grafički prikazi proizašli iz analize ovisnosti geometrijskih karakteristika ribljih staza ovisno o hidrauličkim uvjetima tečenja na temelju kojih se, za zadane osnovne projektne parametre, može konceptualno oblikovati riblja staza. Projektni parametri u ovom radu, osim slatkovodnim ribljim vrstama Hrvatske, prilagođeni su i malim hidroelektranama, gradnja kakvih se, u većem broju, očekuje u Hrvatskoj u idućih desetak godina. Riblje staze u Hrvatskoj građene su dosad na dravskim hidroelektranama, međutim, za njihovo projektiranje nisu dostupni priručnici na hrvatskom jeziku niti norme koje bi mogle omogućiti jednostavnije i sustavno projektiranje ribljih staza u ovisnosti o ulaznim podacima. Težnja ovog rada je da posluži kao podloga za rane faze projektiranja ribljih staza. Također je u radu dana usporedba proizašlih rezultata za promatrane tipove ribljih staza te su naglašene prednosti i nedostaci pojedinog tipa riblje staze, u odnosu na ostale promatrane tipove.

2. STANJE PODRUČJA

Vodni tokovi mogu se promatrati kao izvori energije i kao izvori raznolikosti ribljih vrsta. Hrvatska ima veći broj vodnih tokova koji su zbog svojih karakteristika pogodni za gradnju malih hidroelektrana. Ti isti vodni tokovi predstavljaju stanište mnogih različitih ribljih vrsta te se ovim bogatstvom ističu u Europi.

2.1. KORIŠTENJE VODNIH SNAGA

Svaki vodni tok nositelj je određene količine energije. Ta se energija u prirodnom toku troši na svladavanje unutarnjih i vanjskih otpora, eroziju korita, transport nanosa i sol. Osnovni princip korištenja snage i energije vode u prirodi je hidrotehničkim građevinama smanjiti rad vode u prirodi i oslobođenu energiju iskoristiti za obavljanje nama korisnog rada, a to je proizvodnja električne energije [1].

Općenito, hidroelektrane su postrojenja u kojima se potencijalna i kinetička energija vode preko turbine, generatora i ostalih dijelova pretvara u električnu energiju. Po instaliranoj snazi se hidroelektrane dijele na:

- Velike hidroelektrane (instalirana snaga veća od 10 MW)
- Male hidroelektrane (instalirana snaga između 10 MW i 500 kW)
- Mini hidroelektrane (instalirana snaga između 500 i 100 kW)
- Mikro hidroelektrane (instalirana snaga između 100 i 50 kW)
- Epiko hidroelektrane (instalirana snaga manja od 50 kW)

Pojam male hidroelektrane se može promatrati s različitih točaka gledišta i razlikuje se od zemlje do zemlje. Mala hidroelektrana je, prema postojećim propisima u Hrvatskoj, određena kao postrojenje za iskorištavanje energije vodotoka s instaliranom snagom do 10 MW. Posebnost malih HE je u tome da je rasprostranjenost i broj potencijalnih lokacija veći što je predviđena snaga instalacije manja. Vodotoke u Hrvatskoj karakteriziraju mali padovi, što ih čini prikladnima za izgradnju malih hidroelektrana [2]. Male hidroelektrane predstavljaju kombinaciju prednosti proizvodnje električne energije iz energije hidropotencijala i decentralizirane proizvodnje električne energije, dok istovremeno pokazuju manje negativan utjecaj na okoliš u usporedbi s velikim hidroelektranama čija se štetnost

opisuje kroz velike promjene ekosustava zbog gradnje velikih brana, utjecaja na tlo, poplavlivanje, utjecaje na slatkovodni živi svijet, povećanu emisija metana i postojanje štetnih emisija u čitavom životnom ciklusu hidroelektrane koje su uglavnom vezane za period izgradnje elektrane, proizvodnje materijala i transport. Male hidroelektrane ne mijenjaju režim tečenja jer se rade pregrade reda veličine nekoliko metara, koji ne izazivaju znatne uspore. Također, male hidroelektrane su uglavnom protočne, pa nema oscilacija vodostaja uzvodno i nizvodno od brane. Također, razvojem tehnologije turbina nastale su takozvane *fish-friendly* turbine kod kojih je, ako ribe zalutaju u turbinu, postotak preživljavanja i do 95% [3]. Ipak, negativan utjecaj na ekosustav tekućica i slatkovodni riblji svijet postoji jer hidroelektrane predstavljaju prepreku prirodnim migracijama ribljih vrsta unoseći tako promjene u ekosustav.

2.1.1. ANALIZA ISKORISTIVOG VODNOG POTENCIJALA U RH

Iako se energija rijeka i potoka u Hrvatskoj koristila od davnina kao npr. za pogon mlinova, sustavna istraživanja mogućnosti za njezino iskorištavanje u hidroenergetske svrhe u malim hidroelektranama na području Hrvatske započela su tek 80-ih godina prošlog stoljeća. Izradom "Katastra malih vodnih snaga u Republici Hrvatskoj" preliminarno je za 63 vodotoka, od ukupno njih 134 analiziranih, utvrđeno postojanje 699 mogućih poteza korištenja (približne vrijednosti ukupne instalirane snage oko 177 MW i tehnički iskoristivog energetskeg potencijala od 570 GWh) koji bi se mogli iskoristiti za izgradnju postrojenja specifične snage do 5 MW. Međutim pokazalo se da je znatno manji broj (njih 18) realno iskoristivih lokacija, jer izgradnja ovakvih zahvata traži ispunjenje i niza preduvjeta (prostorni planovi, zaštita prirodne i kulturne baštine, biološki minimum itd.) koji u vrijeme spomenutih istraživanja nisu adekvatno uzimani u obzir. U rasponu snaga hidroelektrana 5 do 10 MW, prema dostupnim izvorima moguća je izgradnja oko 125 MW [4].

U Hrvatskoj trenutno postoje male hidroelektrane ukupne instalirane snage 72,9 MW. Od toga je 4,9 MW u privatnom, a 68 MW u državnom vlasništvu.

Prema dokumentu Strategija energetskeg razvoja Republike Hrvatske (NN 130/09) utvrđeno je da je cilj energetskeg razvoja Hrvatske izgradnja sustava uravnoteženog razvoja odnosa između sigurnosti opskrbe energijom, konkurentnosti i očuvanja okoliša, koji će hrvatskim građanima i hrvatskom gospodarstvu omogućiti kvalitetnu, sigurnu, dostupnu i dostatnu opskrbu energijom. Prema tome se predviđa da se do 2020. godine izgradi barem 100 MW malih hidroelektrana.

2.2. SLATKOVODNE RIBLJE VRSTE U HRVATSKOJ

Slatkovodna ihtiofauna Hrvatske vrlo je raznolika. Bogatstvo vrsta, a posebice endema, svrstava nas u jednu od ihtiološki najraznolikijih zemalja Europe. Tako, sa svoje 154 riblje vrste, Hrvatska zauzima drugo mjesto u Europi, odmah iza Turske, čiji je teritorij znatno veći. Posebno, kao jedno od najvažnijih središta raznolikosti ihtiofaune u Europi ističe se jugozapadni dio Hrvatske. Vodotoke ovog područja naseljava veliki broj endemskih vrsta i podvrsta, a na osnovi postojećih saznanja, za očekivati je i otkrivanje novih vrsta.

Veliko bogatstvo očituje se velikom raznolikošću među našim slatkovodnim ribama; od najvećih europskih riba, kao što su moruna *Huso huso* (do 5 m i 1500 kg) i som *Silurus glanis* (do 5 m i 300 kg), pa do najmanjih kao što je glavocic *Knipowitschia panizzae* (do 2,5 cm, maksimalno 4 cm). Sve riblje vrste koje žive u slatkim vodama Hrvatske pripadaju razredu *Actinopterygii* (zrakoperke) i redovima *Chondrostei* (štitonoše) i *Teleostei* (prave koštunjače). U Hrvatskoj nalazimo oko 150 vrsta slatkovodnih riba raspoređenih u 29 porodica i 15 redova.

Ovo bogatstvo posljedica je zemljopisnog položaja Hrvatske, koji obuhvaća dva riječna sustava: crnomorski i jadranski sliv. Crnomorski ili dunavski sliv Hrvatske zauzima površinu od 35 132 km², a nastanjuje ga 81 vrsta riba. Od toga 62 vrste naseljavaju isključivo ovaj sliv, a 18 vrsta dolazi u oba sliva. Tu nalazimo 68 autohtonih vrsta, a ostalih 13 su alohtone vrste unesene uglavnom tijekom prošlog stoljeća. U jadranskom slivu, ukupne površine 21 405 km² obitava 88 vrsta riba. Od toga 69 vrsta naseljava isključivo ovaj sliv, a 18 vrsta dolazi u oba sliva. U vodotoke jadranskog sliva uneseno je 14 alohtonih vrsta, te niz vrsta koje primarno naseljavaju dunavski sliv [5].

3. RIBLJE STAZE

Riblje staze su konstrukcije kojima se olakšava primarno uzvodna ali i nizvodna migracija ribljih vrsta i drugih organizama u rijekama preko poprečnih prepreka kao što su brane i ustave. Naime, antropogenim učincima mijenja se izgled rijeka, a time i stanište ribljih vrsta, na kakvo su one navikle. Da bi se njihovi biološki procesi mogli neometano odvijati moraju im se osigurati za to odgovarajući uvjeti. Pošto se izgradnjom pregrade na rijeci, npr. u svrhu izgradnje hidroelektrane, onemogućuje nesmetana migracija ribljih vrsta ona se mora osigurati za to predviđenim konstrukcijama, a to su najčešće riblje staze. Migracija se primarno mora osigurati u uzvodnom smjeru. Nizvodna migracija može se ostvariti i preko preljeva brane, pogotovo kod malih hidroelektrana koje imaju malu visinsku razliku gornje i donje vode. Riblje staze mogu biti izvedene kao betonske konstrukcije u obliku kanala s pripadajućim pregradama (*Slika 1*), ili kao kanali koji imitiraju prirodno stanje vodotoka, odnosno koji za pregrade i obloge koriste prirodne materijale riječnog korita. Problem pri odabiru i koncipiranju riblje staze često je nedostatak podataka o plivačkim sposobnostima i navikama ribljih vrsta određenog područja, a ti podaci su ulazni parametri hidrauličkog oblikovanja riblje staze. Rješenje tog problema leži u usvajanju vrijednosti za koje se smatra da odgovaraju širem broju ribljih vrsta te praćenju učinkovitosti riblje staze. Zbog navedenih razloga oblikovanje ribljih staza zahtjeva multidisciplinarni pristup problemu i blisku suradnju biologa (ihtologa) i građevinskih inženjera (projektanata) kako bi riblja staza uspješno obavljala svoju funkciju. Također, potrebno je vršiti redovita mjerenja i kontrolu učinkovitosti riblje staze kako bi se mogla ispitati njena valjanost.



Slika 1. Prag male hidroelektrane sa ribljom stazom[6]

3.1. VAŽNOST RIBLJIH STAZA

Dugi niz godina ekosistemi tekućica razvijali su se bez nekog većeg ljudskog utjecaja. Takvim razvojem živi organizmi naselili su područja njima odgovarajuće geologije i klime, brzina toka, temperature i sadržaja kisika ili su se njima u dugom nizu godina prilagodili [7]. Također organizmi su zbog različitih potreba navikli migrirati između staništa. Neke riblje vrste poduzimaju migracije unutar jedne godine između staništa za hranjenje i odmor ili naseljavaju tijekom svog životnog ciklusa različite dijelove rijeke koji nude uvjete za zadovoljavanje njihovih zahtjeva u različitim životnim fazama. Brojne riblje vrste na kraju ljeta sele u zimska staništa koja su locirana obično u donjim potezima rijeka te time i tokovima manje brzine. Ondje se ribe sele na dno rijeke gdje ostaju kroz hibernaciju i usporavaju metabolizam.

Osnovne vrste migracije su: migracija mriještenja te migracija između slane i slatke vode. Migracije radi mriještenja su posebne vrste migracije između različitih dijelova obitavališta vrste. Poduzete su od strane autohtonih ribljih vrsta unutar riječnog sistema u kojem žive. Takve migracije poduzimaju mrena i smeđa pastrva. Ako je migracija onemogućena nekom nepremostivom preprekom, riblje vrste se mogu mrijestiti na dijelu rijeke gdje su uvjeti manje pogodni. Ovo rezultira manjom obnovom vrste ili potpunim izostankom reprodukcije te istrebljenjem vrste iz staništa [6]. Kod vrsta koje migriraju između ekosistema slatke i slane vode izdvajaju se vrste *Catadormous* kao npr. jegulja koja migrira kao odrasla da bi se reproducirala u slanoj vodi, te vrsta *Anadormous* kao npr. losos, pastrva, jesetra i paklara, koje migriraju u slatku vodu kada su seksualno zrele, da bi se mrijestile u gornjim potezima rijeka. Mlade ribe migriraju opet u slanu vodu, u kojoj rastu, sve dok spolno ne sazriju. Onemogućavanje ovakve migracije dovodi do izumiranja vrsta.

Osim spomenutih razloga, migracije mogu biti potaknute i drugim, različitim uzrocima. Jedan od uzroka može biti i ekološka katastrofa, kao npr. poplava ili onečišćenje vode, zbog čega organizmi migriraju nizvodno. Mobilnost vodnih organizama bitna je i u rekolonizaciji vodnih tijela ili njihovih dijelova koji su opustošeni i dekolonizirani nekim katastrofalnim događajem.

Kao što je navedeno mnoge riblje vrste kroz razne faze svog života rade manje ili veće migracije iz jednog dijela rijeke u drugi, a uzdužna povezanost rijeka nužan je preduvjet za zadržavanje biološke raznolikosti vrsta koje žive u prirodnim vodnim tokovima. Međutim raznim antropogenim utjecajima, kao što su brane i ustave, rijeke su građevinama nesavladivim za riblje vrste odijeljene u sekcije. Uzdužna povezanost nije problem isključivo kod velikih rijeka koje su pregrađene branama, nego se taj problem javlja čak i kod zahvata na manjim vodotocima, kao što je izgradnja hidrotehničkih stepenica ili propusta. Svako malo nadvišenje u vodotoku može biti preveliko za određenu riblju vrstu da ga svlada. Ta uzdužna nepovezanost riječnog toka, uz problem zagađenja vode, dovodi do smanjenja veličine riblje populacije ili u težim slučajevima i do potpunog odumiranja pojedinih ribljih vrsta.

Čovjek je takve situacije svjestan već dugo vremena, ali su se u prošlosti često primjenjivala rješenja neprikladna kako za riblju populaciju, tako i za iskorištavanje energije vode. Jedno od rješenja bilo je i prekidanje rada hidroelektrana kroz periode za koje je procijenjeno da se odvija migracija pojedine vrste. To je dovodilo do velikih ekonomskih gubitaka i zaštite samo pojedinih ribljih vrsta. Danas se rješenja provode uglavnom izgradnjom ribljih staza.

3.2. TIPOVI RIBLJIH STAZA

Konstrukcije ribljih staza razvijale su se empirijski kroz dugo vremensko razdoblje, u različitim dijelovima svijeta, što je rezultiralo velikim brojem različitih tipova ribljih staza. Tipovi ribljih staza razlikuju se primarno po pregradama postavljenim u ribljoj stazi. Određenim oblikom i rasporedom pregrada postižu se pogodni uvjeti tečenja za migraciju ribljih vrsta područja na kojem se riblja staza gradi. Osnovna podjela ribljih staza na tipove može se izraziti kao podjela na tehničke riblje staze i na prirodne riblje staze. Osim ovih uobičajenih konstrukcija postoje i konstrukcije kao što su riblji liftovi [8].

3.2.1. TEHNIČKE RIBLJE STAZE

Tehničke riblje staze su betonske konstrukcije koje potrebne uvjete tečenja ostvaruju stvaranjem umjetno povećane hrapavosti i pregradama s raznim otvorima. Najzastupljenije tehničke riblje staze su: staze s bazenima, staze s vertikalnim prorezima, Denilove staze, kanali s umjetno povećanom hrapavosti i riblji liftovi.

3.2.1.1. STAZE S BAZENIMA

Staze s bazenima se konstruiraju na principu da se ukupni pad svlada manjim padovima kroz niz bazena. Bazeni su odvojeni vertikalnim pregradama koje u sebi sadrže otvore kroz koje ribe plivaju (*Slika 2*). Otvori se postavljaju na naizmjeničnim stranama. Tok vode iz jednog u drugi bazen se može odvijati na više načina. Voda može prolaziti kroz otvor na dnu pregrade, što je pogodno ribama koje ne mogu preskakati pregrade, može se prelijevati preko pregrade, što zahtjeva da riba preskače pregradu, ili pregrada može imati kombinaciju istjecanja i prelijevanja. Kanal i pregrade su uglavnom pravokutne, iako mogu biti i trapeznog ili trokutnog oblika[9]. Ovaj tip riblje staze bit će predmet proračuna u radu.

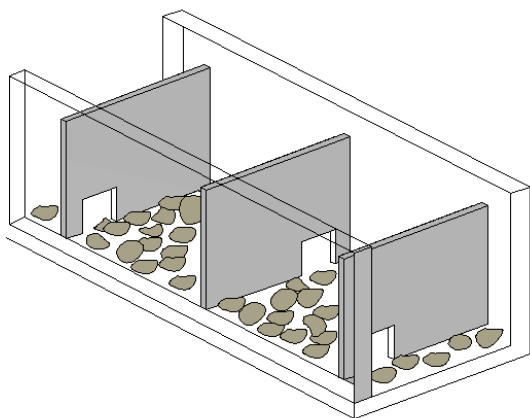

Slika 2. Riblja staza s bazenima

3.2.1.2. STAZE S VERTIKALNIM PROREZIMA

Ovaj tip staza je varijacija staza s bazenima kod kojih pregrada ne ispunjava cijeli poprečni presjek, nego je na mjestima prerezana po cijeloj visini (*Slika 3*). Pregrade

mogu imati jedan ili dva proreza, ovisno o veličini staze i zadanom protoku. U slučaju jednog proreza oni se postavljaju uvijek na istu stranu, za razliku od staza s bazenima gdje se otvori u pregradama postavljaju naizmjenično [9].

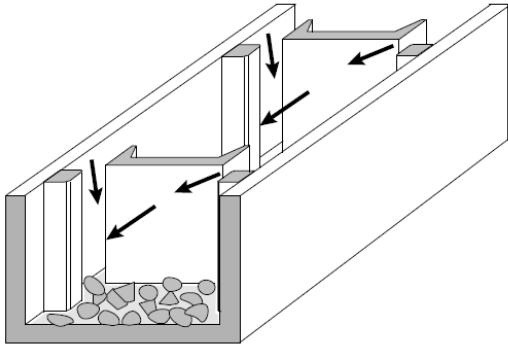

Slika 3. Riblja staza s vertikalnim prorezima[9]

3.2.1.3. DENILOVE STAZE

Staza se sastoji od linearnog kanala u kojem su pregrade raspoređene u relativno kratkim intervalima (*Slika 4*). Pregrade su nagnute u smjeru protoka. Radi velike disipacije energije na pregradama u donjem dijelu pregrade se stvaraju uvjeti relativno malih brzina. Vrlo su pogodne za velike padove jer se radi velikog gubitka energije na pregradama duljina staze znatno skraćuje u odnosu na druge tipove ribljih staza. Njihova primjena bi u hrvatskim geografskim uvjetima bila ograničena, jer bi se za slučajeve malih protoka moglo dogoditi da razina vode bude niska, što bi značilo da riblje vrste pregradu moraju savladati preskakanjem [10].

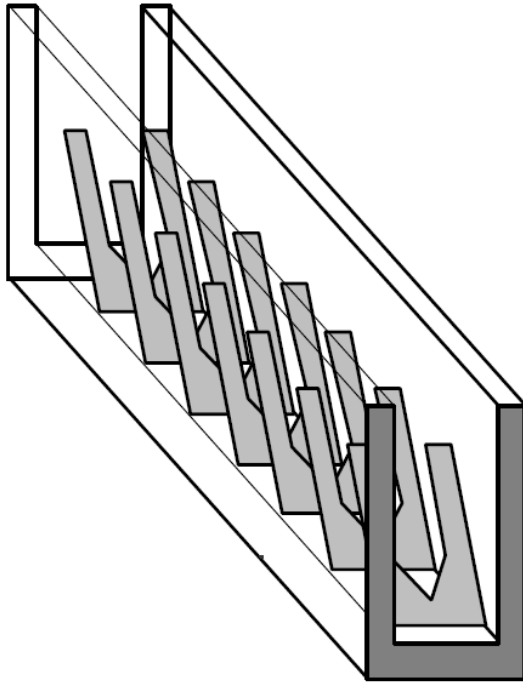

Slika 4. Denilova riblja staza [10]

3.2.1.4. KANALI UMJETNO POVEĆANE HRAPAVOSTI

Kod ovog tipa ribljih staza se traženi uvjeti u kanalu ostvaruju izgradnjom naizmjeničnih pragova u dnu kanala, čime se umjetno povećava hrapavost kanala, te povećava disipacija energije. Povećanje gubitaka uzrokuje smanjenje brzine tečenja. Raspored i visina pragova se određuje hidrauličkim proračunom za zadane protoke i potrebne brzine toka. Pragovi se mogu oblikovati i raspoređivati na različite načine pa se tako dobivaju i različiti podtipovi ovih ribljih staza. Među njima se ističe pet podtipova najčešćih u inženjerskoj praksi: tip s normalnim rebrima, tip s normalnim naizmjenično postavljenim rebrima, tip sa cik-cak rebrima s jednim prijelomom protiv smjera strujanja, tip sa cik-cak rebrima sa dva prijeloma protiv smjera strujanja i tip sa cik-cak rebrima sa dva prijeloma u smjeru strujanja. Ribljim vrstama je omogućeno da plivaju između prepreka u zonama sporijeg tečenja. U hidrauličkom proračunu će se razmatrati tip sa normalnim naizmjenično postavljenim rebrima (Slika 5) [11].

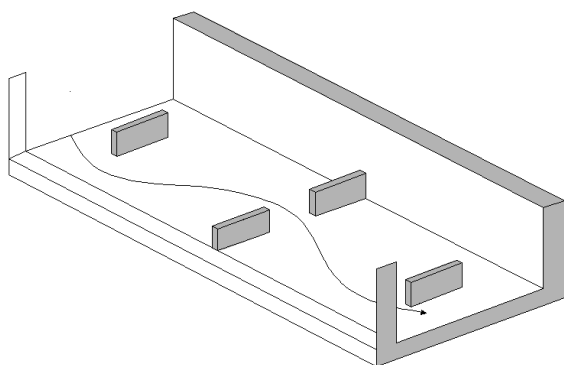

Slika 5. Kanal umjetno povećane hrapavosti s normalnim naizmjenično postavljenim rebrima

3.2.2. PRIRODNE RIBLJE STAZE

Prirodne riblje staze konstruiraju se kao trapezni kanali u kojima se traženi hidraulički uvjeti tečenja ostvaruju raspoređivanjem kamenih blokova po kanalu (Slika 6). Kanal se oblaže prirodnim riječnim materijalom, da bi što vjernije imitirali tečenje u prirodnim vodotocima. Broj i međusobna udaljenost kamenih blokova se određuje na temelju iteracijskog hidrauličkog proračuna, a ovise o zadanom protoku i padu kojeg treba savladati. Za sve ulazne parametre potrebno je dobiti takav raspored i broj kamenih blokova koji će omogućiti održavanje brzine tečenja u granicama koje riba može podnijeti [7].



Slika 6. Prirodne riblje staze [12]

Tipične vrijednosti uzdužnog nagiba su od 1:3 do 1:10. Na podlozi od šljunka ili geotekstila postavlja se „tepih“ od najmanje dva sloja lomljenog kamena (donji sloj je od sitnijeg, a gornji od krupnijeg kamena). U podlogu treba ukomponirati krupne kamene blokove promjera 0,6 do 1,0 m u nepravilnom rasporedu. Dubina toka na kamenoj rampi treba biti od 1/3 do 1/2 denivelacije, tj. razlike kota nivoa na uzvodnom i nizvodnom kraju staze. Nizvodno od riblje staze, korito je zaštićeno od erozije tepihom od kamena na dužini koja nije manja od 10 denivelacija, odnosno 5m. Obale se štite od erozije oblogom od kamenog nabačaja i vegetacijom, koja doprinosi estetskoj kvaliteti ambijenta [13]. Stabilnost riblje staze počiva na pravilnom izboru krupnoće kamena koji čini podlogu rampe.

Ovaj tip ribljih staza je okupio ekološke istomišljenike u dizajnerskom pogledu jer se najbolje uklapaju u riječni okoliš. Sama učinkovitost ovog tipa zahtijeva praćenje na 3 razine (strukturnoj, hidrauličkoj i biološkoj) u cilju osiguranja početnih i dugoročnih rezultata. Za ovaj tip ribljih staza također će biti prikazan hidraulički proračun.

3.2.3. RIBLJI LIFTOVI

U slučaju velikih visinskih razlika koje treba savladati riblja staza i u uvjetima gdje imamo malo vode na raspolaganju nije ekonomski isplativo raditi konvencionalne riblje staze. Također osim velike visinske razlike problem mogu biti i fiziološke sposobnosti ribe. U takvim situacijama se rješenje provodi izgradnjom ribljih liftova koji onda prenose ribe s razine donje vode do razine gornje vode. Rješenje se provodi tako da se na razini donje vode ribe "navuku" u spremnik koji ih onda podiže na razinu gornje vode i otvara im se prolaz [7].

3.3. OBLIKOVANJE ULAZA I IZLAZA IZ RIBLJIH STAZA

Da bi riblja staza bila uspješno oblikovana riblje vrste moraju biti privučene u riblju stazu. Zbog toga je bitan detalj ribljih staza, kao jedan od presudnih faktora njene učinkovitosti, ulaz u riblju stazu. On treba biti formiran tako da privuče ribe da uđu u riblju stazu. Za ispravno funkcioniranje ulaza, najbitnije je dobro ga postaviti u prostoru. Naime, dok je kod nepregrađene rijeke cijela njena širina dostupna za migraciju živih vrsta, u pregrađenim rijekama za migraciju ostaje uzak prostor riblje staze. Zbog toga ulaz treba oblikovati tako da ga živi organizmi prepoznaju i da mogu ući u njega. Kod promatranja uzvodnih migracija bitno je da organizmi obično migriraju u glavnoj struji ili uzduž nje te ulaz mora biti smješten na strani obale, na kojoj je strujanje najveće, a to je vanjska (konkavna) obala. Zbog toga je riblju stazu najbolje postaviti na istoj strani kao i strojarnicu hidroelektrane. Također ulaz u riblju stazu treba biti postavljen što bliže brani ili izlazu iz turbine hidroelektrane[7]. Postavljanje ulaza blizu pregrade smanjuje mogućnost da će riba zalutati, jer se smanjuje veličina mrtve zone između ulaza u stazu i pregrade (*Slika 7*).

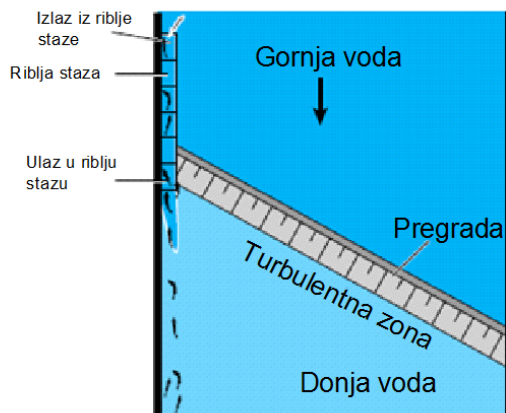

Slika 7. Prikaz pravilno postavljenog ulaza u riblju stazu i migracije kroz njega

Drugo rješenje može biti da se riblja staza postavi na strani preljeva. Takva riblja staza je bitna kod pojave velikih voda, kada je protok u vodotoku veći od instaliranog protoka male hidroelektrane. Tada će se dio vode prelijevati, a takvo će strujanje privući ribe. Također, riblja staza postavljena na strani preljeva može biti korištena za osiguranje protoka potrebnog za zadovoljavanje biološkog minimuma. Rijetko se u praksi rade staze na oba mjesta, iako je i to rješenje moguće (*Slika 8*). Najčešće se postavlja samo na strani gdje je turbina.

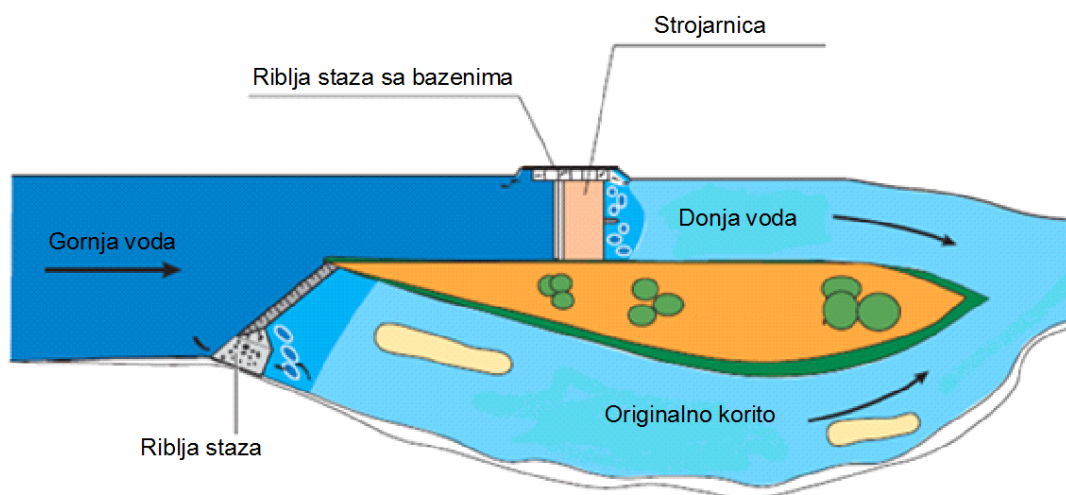

Slika 8. Mogući načini postavljanja riblje staze

Da bi se stvorili uvjeti strujanja u ribljoj stazi koji će privući riblje vrste moraju biti ispunjeni određeni zahtjevi za izlazne brzine i protoke. Pri tako ispunjenim uvjetima postojat će privlačna struja koja će ulaz u riblju stazu učiniti zamjetnim za riblje vrste. Brzina izlaza privlačne struje iz riblje staze treba biti između 0,8 i 2,0 m/s. Protok kroz riblju stazu treba biti dovoljno velik da bi se mogao zamijetiti u strujanju vode s nizvodne strane brane, u vrijeme migracije. To znači između 1 i 5 posto nizvodnog protoka. Veći protok značit će naravno veću privlačnu struju [14]. Da bi se osigurao siguran izlaz ribljih vrsta iz riblje staze izlaz iz riblje staze, u slučaju zaobilaženja hidroelektrana, treba biti postavljen minimalno 5 m daleko od ulaza u turbinu elektrane da ribe ne budu strujom uvučene prema turbini elektrane. Ako je brzina dolaznog toka u turbinu veća od 0,5 m/s, izlazno područje riblje staze treba biti produženo izgradnjom pregradnog zida. Također snažna turbulencija i brzine preko 2,0 m/s trebaju biti izbjegavane na izlaznom području, da bi se omogućilo lakše izlaženje riba u gornju vodu [7].

Osim toga, trebao bi se omogućiti smještaj kontrolnih uređaja na izlazu iz riblje staze, kako bi se motrila njena učinkovitost i omogućilo zaustavljanje protoka kroz riblju stazu za svrhe održavanja i kontrole rada riblje staze.

Rješavanje problema migracija ribljih vrsta onemogućenih pregrađivanjem rijeka je počelo prvenstveno rješavanjem uzvodnih migracija. Problem nizvodnih migracija je prepoznat tek u novije vrijeme, te puno manje proučavan. Česti primjer nepogodno riješene nizvodne migracije je prolaz riba preko preljeva brane. Radi velike brzine

kojom ribe mogu padati, te izražene turbulencije u zoni ispod preljeva, prolaz riba preko preljeva može ribljim vrstama izazvati ozbiljne ozljede ili čak smrtne posljedice. Ako i ne dođe do takvih posljedica postoji mogućnost da dođe do dezorijentiranosti riba uslijed šoka nakon pada. Manje ribe puno bolje podnose ovakve padove, dok velike u većini slučajeva imaju posljedice. Također, u nizvodnim migracijama postoji opasnost da ribe zalutaju u turbinu. Pri prolasku riba kroz turbinu posljedice također ovise o veličini i vrsti ribe, ali i o tipu turbine [15]. Objekti za nizvodne migracije imaju funkciju da ribe na siguran i efikasan način usmjere prema ribljoj stazi. Postoji dosta različitih načina za ostvarivanje takvog usmjeravanja, no nisu svi jednako učinkoviti, te se kao rješenja još istražuju. Objekti mogu biti u obliku barijera koje fizički usmjeravaju ribe prema stazi ili u obliku barijera koje usmjeravaju ribe u stazu preko nekog oblika poticaja. Najpoznatiji takav usmjerivač je bio-akustična ograda. Ona koristi zavjesu mjehurića koja sadržava zvučni signal koji se generira pneumatski. Efektivno, to stvara "zvučni zid" (kratkotrajno zvučno polje) koji se može koristiti za usmjeravanje ribe do riblje staze. Fizikalno, bio-akustične ograde se sastoje od pneumatske sonde za proizvodnju zvuka u kombinaciji s generatorima mjehurića, što uzrokuje zvučni val koji se propagacijom diže unutar zastora mjehurića. Zvuk je sadržan unutar mjehurića zavjese kao posljedica loma, jer je brzina zvuka u mješavini vode i zraka (mjehurić) različita od onoga u vodi ili zraka samima.

3.4. OBLIKOVANJE DNA

Dno riblje staze treba biti prekriveno cijelom dužinom riblje staze slojem hrapavog supstrata od najmanje 0,2 metra debljine. Idealno, supstrat bi trebao biti onaj koji je tipičan za tu rijeku. S hidrauličkog gledišta supstrat je neophodan za sprečavanje erozije dna. Osim toga, supstrat bi trebao biti što bliže prirodnom za dano područje i trebao bi formirati mozaik mnoštva različitih veličina i oblika praznina, na temelju različitih veličina zrna supstrata. Mala riba, mlada riba i posebno benetički organizmi mogu se povući u takva područja malog strujanja i biti zaštićeni. Hrapavo dno mora biti kontinuirano od ulaza do uključivo izlaza iz riblje staze, uključujući i proreze i otvore [16].

4. HIDRAULIČKO OBLIKOVANJE RIBLJIH STAZA

Hidrauličkim oblikovanjem ribljih staza postižu se zahtijevani uvjeti tečenja, pogodni pojedinim ribljim vrstama. Da bi uvjeti tečenja bili povoljni, općenito govoreći turbulencija toka u ribljim stazama trebala bi biti što je manja moguća tako da svi organizmi mogu migrirati, bez obzira na njihove plivačke sposobnosti. Pravilo je da tok u ribljoj stazi bude laminaran. Migracija organizama nadalje omogućuje se pogodnim hidrauličkim oblikovanjem staze u pogledu stvaranja odgovarajuće brzine tečenja u kanalu i ostvarivanje dovoljne volumne disipacije energije u bazenima. Općenito se preporuča da maksimalna brzina tečenja koja se može ostvariti na suženjima, procjepima i otvorima ribljih staza bude ispod $2,0 \text{ m/s}$, a još manja brzina tečenja trebala bi biti na ostalim dijelovima riblje staze. Preporuka za hrvatske slatkovodne riblje vrste je da se u ribljim stazama ostvari brzina tečenja između $1,0$ i $1,5 \text{ m/s}$. Brzina u pridnenim dijelovima treba biti manja što se ostvaruje hrapavim supstratom položenim po dnu. Ostvarivanje volumne disipacije energije bitno je da bi se slabi plivači mogli odmoriti prilikom uzvodne migracije. U tu svrhu grade se bazeni s volumnom disipacijom energije $150-200 \text{ W/m}^3$ bazena [7]. Odgovarajući uvjeti tečenja ostvaruju se ovisno o tipu riblje staze i ulaznim parametrima.

Ulazni parametri su:

- Protok $Q [l/s]$ - prema preporuci biologa: $100-400 [l/s]$
- Razlika vodnih lica gornje i donje vode Δh - za male HE 2-6 metara
- Odabrana širina kanala $b[m]$
- Zahtijevana brzina tečenja $v [m/s]$ - prema preporuci biologa za hrvatske slatkovodne ribe ne preko $1,5 \text{ m/s}$

Ovisno o tipu riblje staze ulazni parametar može biti i duljina riblje staze ili je ona rezultat proračuna uz neke druge pretpostavljene elemente oblikovanja.

Kao izlazni definirani su visina pregrada, razmak pregrada, veličine otvora ili neki drugi parametri kojima se ostvaruju zahtijevani uvjeti tečenja.

4.1. PRORAČUN RIBLIJH STAZA S NORMALNIM NAIZMJENIČNO POSTAVLJENIM REBRIMA

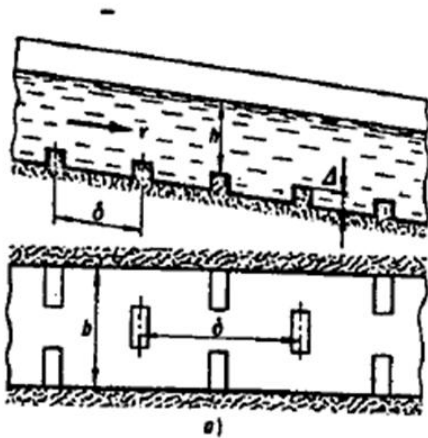

Slika 9. Pogled i tlocrt brzotoka s normalnim naizmjenično postavljenim rebrima [11]

Proračun ribljih staza s normalnim naizmjenično postavljenim rebrima provodi se kao hidraulički proračun brzotoka s umjetnom hrapavošću. Izazivanjem umjetne hrapavosti u brzotoku povećavaju se otpori tečenju pa se smanjuje brzina tečenja u brzotoku, za dani nagib brzotoka. To je zahtijevano pri projektiranju ribljih staza jer se na taj način može savladati traženi pad vodnog lica manjom duljinom vodotoka, a da se ipak ostvare povoljne brzine tečenja za migraciju ribljih vrsta. Povećana hrapavost postiže se umetanjem rebara koji u brzotoku stvaraju lokalne otpore u obliku naglog proširenja i naglog suženja. Rebra se postavljaju na međusobnu udaljenosti $\delta = 7\Delta$ jer se pri tom ostvaruje najveća hrapavost, uz ostale jednake uvjete [11]. Također pri izvedbi ovakvog brzotoka mora vrijediti uvjet $\frac{h}{\Delta} > 3$ jer se pri tom uvjetu energetski pad, pad vodnog lica i pad dna brzotoka mogu smatrati jednakima što je bitno jer se time osigurava primjenjivost jednadžbe jednolikog tečenja na ovakvom brzotoku.

Iznos Darcyevog koeficijenta hrapavosti za tako izveden brzotok je:

$$\lambda = M + 2i^2 - N \cdot i \cdot \log i \left(\frac{\Delta}{h} \cdot \frac{b}{\chi} \cdot \frac{1}{\sqrt{\Pi_k}} \right)$$

Pri čemu je:

M i N - brojčani parametri koji ovise o tipu pojačane hrapavosti, određuju se eksperimentalno. Za brzotok s normalnim naizmjeničnim rebrima smještenima na udaljenosti $\delta = 7\Delta$ i uz uvjet $\frac{h}{\Delta} > 3$ određeno je: $M = 0.077$ i $N = 18$

i - pad strmog žlijeba brzotoka [m/m]

Δ - visina rebara za stvaranje hrapavosti [m]

h - dubina protoka iznad rebra [m]

b - širina žlijeba u dnu [m]

χ - omočeni perimetar (obod) [m]

$\frac{b}{\chi}$ - prikazuje utjecaj hrapavosti koja nastaje od rebara [1]

Π_k - parametar kinetičnosti, za brzotoke pravokutnog presjeka je

$$\sqrt{\Pi_k} = \frac{q}{\sqrt{g \cdot h \sqrt{h}}} = \frac{v}{\sqrt{gh}}$$

Oznake pojedinih parametara dane su i na definicijskoj skici (Slika 9).

Također vrijedi izraz za hidrauličke gubitke pri jednolikom tečenju:

$$\lambda = \frac{8gRi}{v^2} = \frac{8gi}{Q^2} \cdot \frac{\omega^2}{\chi}$$

Rješavanjem dana dva izraza, dobije se:

$$\Delta = \frac{\frac{8g}{Q^2} \cdot \frac{\omega^3}{\chi} - \frac{M + 2i^2}{i}}{-N \log i} \cdot h \frac{\chi}{b} \sqrt{\Pi_k}$$

Time je definirana visina rebara koja je potrebno postaviti na razmaku $\delta = 7\Delta$, da bi se tečenje odvijalo brzinom v , pri padu brzotoka i i protoku Q .

PRIMJER PRORAČUNA:

Ulazni parametri:

$$v = 1 \text{ m/s}$$

$$Q = 200 \text{ l/s}$$

$$\Delta h = 3 \text{ m}$$

$$b = 1 \text{ m}$$

$$L = 30 \text{ m}$$

Prvo se proračunavaju parametri:

$$\omega = \frac{Q}{v} = \frac{0.2}{1} = 0.2,$$

$$h = \frac{\omega}{b} = \frac{0.2}{1} = 0.2 \text{ m}$$

$$\chi = b + 2 \cdot h = 1 + 2 \cdot 0.2 = 1.4 \text{ m}$$

$$\Pi_k = \frac{v^2}{g \cdot h} = \frac{1^2}{9.81 \cdot 0.2} = 0.51$$

$$i = \frac{\Delta h}{L} = \frac{3}{30} = 0.1 \text{ m/m}$$

Potom se prema izrazu $\Delta = \frac{8g \cdot \frac{\omega^3}{Q^2} - \frac{M + 2i^2}{\chi}}{-N \log i} \cdot h \frac{\chi}{b} \sqrt{\Pi_k}$ računa potrebna visina pregrada.

$$\Delta = \frac{8g \cdot \frac{\omega^3}{Q^2} - \frac{M + 2i^2}{\chi}}{-N \log i} \cdot h \frac{\chi}{b} \sqrt{\Pi_k} = \frac{8 \cdot 9.81 \cdot \frac{0.2^3}{0.2^2} - \frac{0.077 + 2 \cdot 0.1^2}{1.4}}{-18 \log 0.1} \cdot 0.2 \cdot \frac{1.4}{1} \cdot \sqrt{0.51} = 0.61 \text{ m}$$

Potrebna udaljenost pregrada iznosi: $\delta = 7\Delta = 7 \cdot 0.61 = 0.81 \text{ m}$

4.2. PRORAČUN RIBLJIH STAZA S BAZENIMA

Proračun ribljih staza s bazenima se temelji na tome da se ovisno o razlici gornje i donje vode koju je potrebno savladati, projektnom protoku i dozvoljenoj brzini tečenja mijenjaju se parametri bazena. Tako se dobivaju različite duljine bazena, padovi koji se savladaju na jednom bazenu, veličine otvora i visine preljeva na pregradama [7].

Dakle, veličina pada koja se svlada na jednom bazenu je u funkciji dopuštene brzine.

Dopuštena brzina v (m/s) : $v = \sqrt{2g\Delta h}$ m/s

Poteškoće kod migracije riba u stazama izaziva i turbulencija i uzburkanost u bazenu. Jednostavni pokazatelj jačine turbulencije i agitacije u bazenu je dan kao brzina disipacije energije u jedinici volumena bazena, koja prema procjenama iznosi $E=150-200 W / m^3$. Kako naprezanje ribe ovisi o kinetičkoj energiji toka, iz izraza za disipaciju energije dobijemo duljinu bazena, takvu da je energija koju ribe troše na stazi u fiziološki prihvatljivim granicama.

$$E = \frac{\rho g \Delta h Q}{b h_m l_b}, \text{ pri čemu je:}$$

E - brzina disipacije energije u jedinici volumena $[W / m^3]$

ρ - gustoća vode $[kg / m^3]$

Δh - pad na jednom bazenu $[m]$

Q - protok $[m^3 / s]$

b - širina bazena $[m]$

h_m - minimalna potrebna dubina u bazenu $[m]$

l_b - duljina bazena $[m]$

Kada znamo duljinu bazena i pad na pojedinom bazenu, iz tih podataka i podataka o ukupnom padu koji je potrebno savladati dobijemo ukupnu duljinu staze.

$$\text{Broj bazena } n: n = \frac{h_{tot}}{\Delta h} - 1$$

h_{tot} - ukupni pad riblje staze [m]

Ukupna duljina staze L (m) : $L = n \cdot l_b$

Parametri su objašnjeni i na definicijskoj skici (Slika 10).

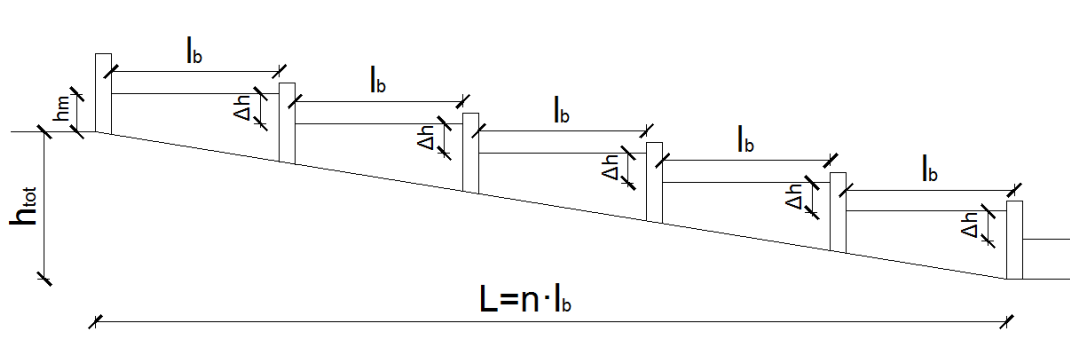

Slika 10. Poprečni presjek kroz riblju stazu s bazenima

Najčešće se staze s bazenima izrađuju u pravcu, no u slučaju prevelike duljine staze ili nekih drugih razloga mogu se konstruirati tako da mijenjaju smjer za 180 stupnjeva jednom ili više puta (Slika 11).

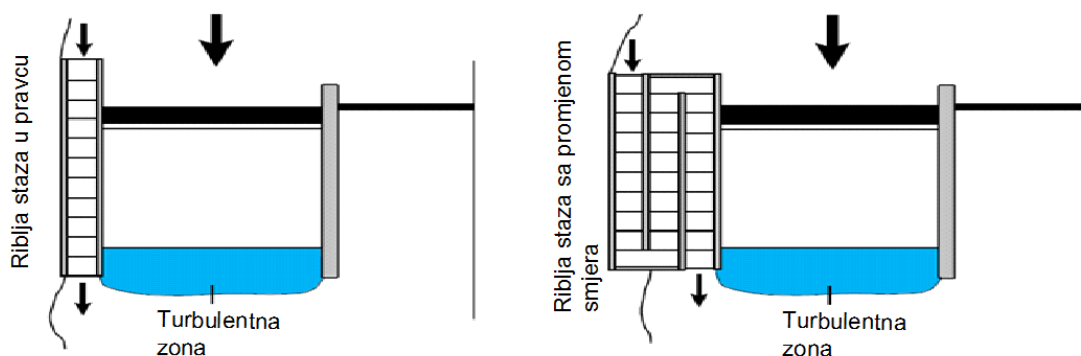

Slika 11. Mogućnosti konstruiranja riblje staze s bazenima

Dimenzije otvora na pregradi ne bi trebale biti manje od 20 cm, čak ni za vrlo male ribe, jer bi se sa manjim otvorima potaklo začepljenje staze potencijalnim nanosima otpada. Minimalna dubina vode u ribljnoj stazi ne smije biti niža od dimenzija otvora na pregradi (Slika 12).

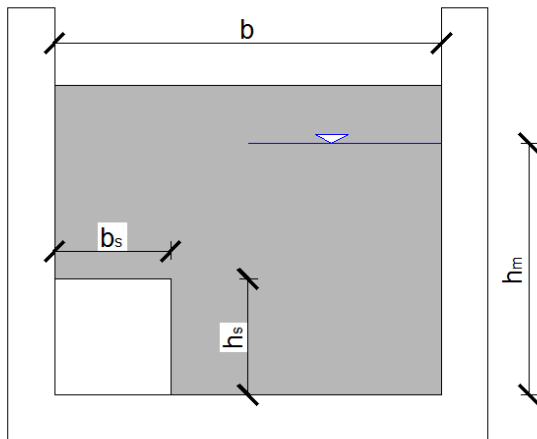

Slika 12. Poprečni presjek kroz riblju stazu s bazenima

Dno riblje staze bi trebalo biti obloženo materijalom velike hrapavosti u funkciji smanjenja brzine u blizini dna i olakšavanja prolaska kroz stazu manjim ribama i drugim bentičkim organizmima. Hrapavo dno može biti izvedeno postavljanjem krupnijeg kamenja po betonu prije nego se stvrdne.

Pregrade na stazama mogu biti betonske ili drvene. Drvene bolje podnose kasnije promjene oblika otvora ili preljeva, ali i je potrebno redovno mijenjati (svakih nekoliko godina).

PRIMJER PRORAČUNA:

Ulazni parametri:

$$v = 1 \text{ m/s}$$

$$Q = 200 \text{ m}^3/\text{s}$$

$$h_{\text{tot}} = 3 \text{ m}$$

$$b = 1 \text{ m}$$

Određivanje pada po pojedinom bazenu Δh :

$$v = \sqrt{2g\Delta h} \text{ m/s}$$

$$\Delta h = \frac{1}{2g} = 0,05 \text{ m}$$

Broj bazena n:

$$n = \frac{h_{tot}}{\Delta h} - 1 = \frac{3}{0,05} - 1 = 59$$

Površina otvora:

$$A_s = \frac{Q}{\psi \cdot v} = \frac{0,2}{0,75 \cdot 1} = 0,266 \text{ m}^2$$

Duljina jednog bazena:

$$l_b = \frac{\rho g \Delta h Q}{E b h_m} = \frac{1000 \cdot 9,81 \cdot 0,05 \cdot 0,2}{150 \cdot 1 \cdot 0,6} = 1,09 \text{ m}$$

Ukupna duljina staze:

$$L = n \cdot l_b = 59 \cdot 1,09 = 64,31 \text{ m}$$

4.3. PRORAČUN PRIRODNIH RIBLJIH STAZA

Hidraulički proračun ribljih staza prirodnog tipa zahtijeva podatke s terena (podaci o dubinama vode, protocima, brzinama tečenja) te njihovu simulaciju na jednom od matematičkih modela. Ovdje će biti korišten matematički model HEC-RAS. Proračun se zasniva na usvajanju dimenzija poprečnog presjeka i protoka te izboru krupnoće, broja i rasporeda kamenih blokova.

Protok se uzima kao minimalni i maksimalni protok. Minimalni protok Q_{min} se najčešće usvaja kao protok zastupljenosti 90-95 % na krivulji trajanja. Pri ovom protoku dubina mora biti dovoljna da omogući nesmetano kretanje riba (najmanje 0.2 m), a najveća brzina toka mora biti ograničena na 2 m/s. Maksimalni protok Q_{max} odgovara povratnom periodu od nekoliko godina i služi za provjeru stabilnosti kamene rampe. U praksi se često usvaja velika voda povratnog perioda 10 godina. Obzirom da je izbor projektne velike vode rezultat tehničko-ekonomske analize (kalkulacija troškova izvedbe i održavanja), ovdje se neće ulaziti u takve analize, te će se dimenzionirati riblja staza na minimalni protok.

Krupnoća kamena se određuje prema empirijskim obrascima. Whittaker i Jäggi definirali su karakteristični promjer kamena d_{65} u ovisnosti od projektnog jediničnog protoka $q_{\max} = f(Q_{\max})$ i uzdužnog nagiba I_d . $d_{65} \approx (q_{\max} \cdot I_d^{7/6})^{2/3}$.

Izraz za srednju krupnoću kamena prema Robinsonu : $d_{50} \approx 0,5 \cdot (q_{\max} \cdot I_d^{0,58})^{0,529}$,

koji važi ako je $d_{50} < 0,3m$, relativnu gustoću kamena $(\rho_s - \rho) / \rho = 2,45 - 2,82$ i nagib staze $10\% \leq I_d \leq 40\%$. Dobivene vrijednosti potrebno je množiti sa faktorom sigurnosti 1,15 do 1,20. Najmanja debljina podloge iznosi $2d_{50}$ [13].

Veličina i raspored kamenih blokova se proizvoljno odabiru. Veličinu kamenog bloka određuju promjer koji se odabire između 0,6 i 1,0 m i visina h_d koja treba biti iznad vodnog lica zbog stabilnosti, a u proračunu se uzima visina h_{pot} koja je jednaka dubini vode. Razmak kamenih blokova jednak je u poprečnom i uzdužnom smjeru, tj. $a_x = a_y$ i iznosi $1,5d$ do $3,0d$.

Nakon toga se računaju geometrijske karakteristike:

- Površina projekcije kamenog bloka : $A_d = d \cdot h_{pot}$
- Površina osnove kamenog bloka : $A_o = d^2 \cdot \pi / 4$
- Zapremnina kamenog bloka : $\forall_k = A_o \cdot h_{pot}$
- Površina kruga kamena $d + a_x / 2$: $A_x = (d + a_x / 2)^2 \cdot \pi / 4$
- Površina dna staze : $A_r = b \cdot L_r$
- Broj kamenih blokova : $n_k = A_r / A_x \rightarrow$ iz čega se zaokruživanjem na cijeli broj usvaja broj potrebnih kamenih blokova: $n_{k,USV}$

koje su potrebne za određivanje hidrauličkog otpora oblika λ_o . Osim hidrauličkog otpora oblika, hidraulički ukupni otpor λ se sastoji i od hidrauličkog otpora trenja λ_k . Spomenuti otpori su empirijski definirani:

$$\frac{1}{\sqrt{\lambda_o}} = -2 \log \left(\frac{k_s}{14,84 \cdot R} \right)$$

$$\lambda_k = 4 \cdot C_d \cdot S_{Ad} / \Omega_r,$$

gdje je

k_s - ekvivalentna pješčana hrapavost (ovisi o prosječnoj veličini kamena d ili najkrupnijeg zrna mješavine u podlozi d_{90} , te hidrauličkog radijusa R)

$S_{Ad} = n_{k,usv} \cdot A_d$ - površina projekcije svih kamenih blokova na površinu okomitu na strujnice

$\Omega_r = O \cdot L_r$ - omočena površina rampe

$C_d = 1,5$ - koeficijent otpora kamenih blokova

Ako se definiraju faktori ponderacije kao:

$$\varepsilon_o = \frac{S_{Ad}}{\Omega_r} \text{ i } \varepsilon_v = \frac{n_{k,usv} \cdot \nabla_k}{A \cdot L_r},$$

ukupni hidraulički otpor jednak je

$$\lambda = \frac{\lambda_k + \lambda_o \cdot (1 - \varepsilon_o)}{1 - \varepsilon_v}.$$

Ukupni hidraulički otpor potreban je za određivanje brzine tečenja. Brzina tečenja dobiva se iz Manningove jednadžbe jednolikog stacionarnog tečenja u funkciji nagiba I_d i ukupnog hidrauličkog otpora λ : $V = \sqrt{8gRI_d / \lambda}$.

Izračunata brzina V množi se sa površinom poprečnog presjeka A te se dobiva računski protok Q . Računski protok Q treba biti približno jednak projektnom protoku Q_{min} . Ukoliko nije, mijenjaju se veličina i raspored kamenih blokova sve dok se ne dobije zadovoljavajući računski protok. Nakon što je dobiven zadovoljavajući protok, potrebno je provjeriti uvjet mirnog tečenja u ribljoj stazi. Uvjet mirnog tečenja vezan je uz vrijednost Froudovog broja, a glasi: $Fr = V^2 B / (gA) < 1,0$.

Postavljanjem kamenih blokova smanjuje se protjecajni presjek pa treba provjeriti brzinu tečenja V_s u tim dijelovima:

$$V_s = V(A / A_s),$$

gdje je aktivna površina toka

$$A_s = A - 3A_d.$$

Provjerava se i Froudov broj u tim dijelovima:

$$Fr = V_s^2 B_s / (g A_s) < 1,7,$$

pri čemu je širina vodnog lica u suženom presjeku :

$$B_s = B - 3d .$$

Ukoliko su spomenuti uvjeti zadovoljeni, projektno rješenje riblje staze je prihvatljivo.

KORIŠTENI MATEMATIČKI MODEL

Za hidrauličke proračune postojećeg i projektnog stanja korišten je matematički program HEC-RAS. HEC-RAS je integrirani matematički program projektiran za interaktivnu upotrebu u okruženju s višestrukim zadaćama matematičkog simuliranja. Matematički modeli HEC paketa koriste se za simulaciju tečenja i proračuna razina na riječnim dionicama, a namijenjeni su za provedbu jednodimenzionalnih (1-D) hidrauličkih proračuna na mreži prirodnih i umjetnih vodotoka. Ovim modelom je moguće ostvariti numeričke pokuse stacionarnog i nestacionarnog strujanja u jednoj dimenziji i jednom vertikalnom homogenom sloju. HEC-RAS se sastoji od četiri jednodimenzionalna modula za: (1) proračun parametara toka za uvjete stacionarnog tečenja, (2) proračun parametara toka za uvjete nestacionarnog tečenja, (3) proračun pronosa nanosa u uvjetima pokretnog korita i (4) analizu kvalitete vode. Sva četiri modula koriste zajedničke podatke o geometriji korita i zajedničke algoritme za provedbu hidrauličkog proračuna[17].

Za potrebe hidrauličkih proračuna korišten je modul za simulaciju stacionarnog tečenja. Ovaj modul programa HEC-RAS je namijenjen proračunu profila vodostaja u uvjetima stacionarnog postepeno promjenjivog toka. Modul je namijenjen proračunu tečenja u samostalnoj dionici, lutajućem koritu ili riječnoj mreži. Moguće je simulirati tečenje u uvjetima mirnog, burnog i mješovitog režima toka.

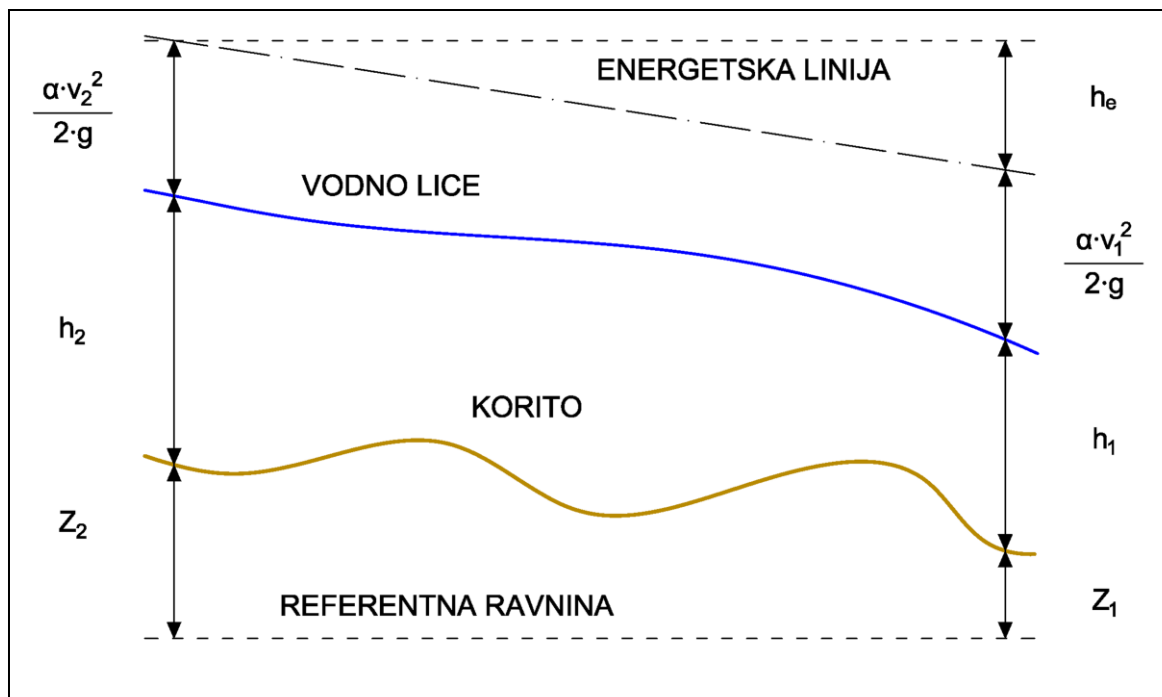

Slika 13. Jednodimenzionalna shema za stacionarni proračun tečenja.

Osnovni algoritam proračuna temelji se na primjeni zakona održanja energije:

$$Z_2 + h_2 + \frac{\alpha_2 \cdot v_2^2}{2g} = Z_1 + h_1 + \frac{\alpha_1 \cdot v_1^2}{2g} + h_e$$

gdje su:

Z_2, Z_1 - razina dna korita [m],

h_2, h_1 - dubina vode [m],

v_2, v_1 - srednja profilska brzina [m/s],

α_2, α_1 - Coriolisov koeficijent korekcije brzine [/],

g - ubrzanje sile teže [m/s^2],

h_e - energetski gubici [m].

Parametri su dani i na definicijskoj skici (Slika 13.)

Energetski gubici su zastupljeni preko linearnih i lokalnih gubitaka, a dani su jednačbom:

$$h_e = L \cdot \bar{I} + C \cdot \left| \frac{\alpha_2 \cdot v_2^2}{2g} - \frac{\alpha_1 \cdot v_1^2}{2g} \right|$$

gdje su:

L - razmak između sukcesivnih poprečnih profila [m],

\bar{I} - pad energetske linije [m/m],

C - koeficijent lokalnog gubitka [l].

Pad energetske linije uslijed linijskog tečenja se procjenjuju na temelju Manningove jednadžbe:

$$v = \frac{1}{n} \cdot R^{\frac{2}{3}} \cdot \bar{I}^{\frac{1}{2}}$$

gdje su:

v - srednja brzina toka između dva sukcesivna profila [m/s],

n - Manningov koeficijent hrapavosti [$m^{-1/3} s$],

R - hidraulički radijus [m].

Kod promjene režima toka, iz mirnog u burni, prelazi se na primjenu zakona održanja količine gibanja. Ovakve situacije se javljaju kod hidrauličkih skokova, mostovskih otvora, propusta i ušća vodotoka:

$$P_2 - P_1 + G_x - F = \rho \cdot Q \cdot \Delta v_x$$

gdje su:

P - sila hidrostatskog tlaka na profilima 1 i 2 [N],

G_x - težina vode unutar kontrolnog profila u smjeru pružanja dna [N],

F - sila uzrokovana trenjem sa dnom [N],

Q - protok [m^3/s],

ρ - gustoća vode [kg/m^3],

Δv_x - promjena brzine između profila 1 i 2 [m/s].

Pri simulaciji tečenja moguće je simulirati i utjecaj različitih građevina na tečenje kao što su: mostovi, propusti, preljevi, pragovi, itd.

PRIMJER PRORAČUNA

Proračun riblje staze započinje određivanjem njezinog poprečnog presjeka i dužine. Dužina riblje staze ovisi o veličini pada koji se savladava. Minimalni protok iznosi $0.4 \text{ m}^3/\text{s}$. Dužina riblje staze iznosi $L_r=100 \text{ m}$, određuje se u ovisnosti nagiba $I_d=0,02$ i pada vodnog lica $\Delta H=2,0 \text{ m}$. Poprečni presjek je trapeznog oblika, visine $0,4 \text{ m}$, širine dna $2,0 \text{ m}$. Dubina vode iznosi $0,3 \text{ m}$. Proračun je iterativan. Prikaz korištenih oznaka dan je na Slici 14.

1) Geometrijske karakteristike poprečnog presjeka.

Površina poprečnog presjeka: $A = h \cdot (b + m \cdot h) = 0,3 \cdot (2,0 + 1,5 \cdot 0,3) = 0,735 \text{ m}^2$.

Omočeni obod: $O = b + 2 \cdot h \cdot \sqrt{1 + m^2} = 2,0 + 2 \cdot 0,3 \cdot \sqrt{1 + 1,5^2} = 3,08 \text{ m}$.

Širina vodnog lica: $B = b + 2 \cdot m \cdot h = 2,0 + 2 \cdot 1,5 \cdot 0,3 = 2,9 \text{ m}$.

Hidraulički radijus: $R = A / O = 0,735 / 3,08 = 0,239 \text{ m}$.

2) Krupnoća kamena

$d_{50} = 0,5 \cdot (q_{\max} \cdot I_d^{0,58})^{0,529} = 0,5 \cdot (0,4 \cdot 0,02^{0,58})^{0,529} = 0,1 \text{ m} < 0,3 \text{ m}$, množi se s faktorom sigurnosti $0,1 \cdot 1,15 = 0,115 \text{ m}$.

Najmanja debljina podloge od ovog kamena iznosi : $2 \cdot 0,115 = 0,23 \text{ m}$, zaokružuje se na $0,3 \text{ m}$.

Usvajaju se dimenzije kamenih blokova :

- Širina $d = 0,6 \text{ m}$
- Visina $h_d = 0,4 \text{ m}$
- Razmak blokova u pravcu i okomito na njega $a_x = a_y = 1,0 \text{ m}$
- Dubina potapanja $h_{pot} = h = 0,3 \text{ m}$

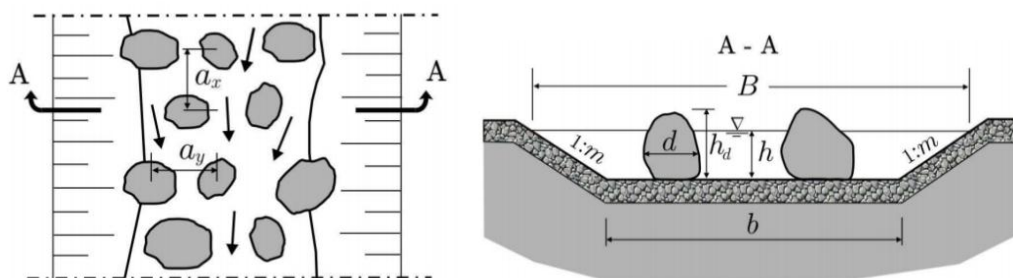

Slika 14. Prikaz korištenih oznaka[13]

Iz usvojenih dimenzija računaju se geometrijske veličine :

- Površina projekcije kamenog bloka : $A_d = d \cdot h_{pot} = 0,6 \cdot 0,3 = 0,18m^2$
- Površina osnove kamenog bloka : $A_o = d^2 \cdot \pi / 4 = 0,6^2 \cdot \pi / 4 = 0,2826m^2$
- Zapremnina kamenog bloka : $\forall_k = A_o \cdot h_{pot} = 0,2826 \cdot 0,3 = 0,085m^3$
- Površina kruga kamena $d + a_x / 2$:
 $A_x = (d + a_x / 2)^2 \cdot \pi / 4 = (0,6 + 1,0 / 2)^2 = 0,949m^2$
- Površina dna staze : $A_r = b \cdot L_r = 2,0 \cdot 100,0 = 200,0m^2$
- Broj kamenih blokova : $n_k = A_r / A_x = 200,0 / 0,949 = 210,55m^2 \rightarrow$
 $n_{k,usvojeno} = 211 \text{ bloka}$

Hidraulički otpori sastoje se od otpora trenja i otpora oblika. Pretpostavljajući turbulentno strujanje po hidraulički hrapavom dnu, otpor trenja se može izračunati pomoću empirijskog izraza (Darcy-Weisbach) za koeficijent trenja :

$$\frac{1}{\sqrt{\lambda_o}} = -2 \log \left(\frac{k_s}{14,84 \cdot R} \right) \rightarrow \lambda_o = 0,134$$

Gdje je k_s ekvivalentna pješčana hrapavost, definirana u funkciji prosječne veličine kamena (d) ili najkrupnijeg zrna mješavine u podlozi (d_{90}), kao i hidrauličkog radijusa (R). [18]

Koeficijent otpora oblika također se definira empirijskim izrazom :

$$\lambda_k = 4 \cdot C_d \cdot S_{Ad} / \Omega_r = 4 \cdot 1,5 \cdot 37,98 / 308,17 = 0,739 ,$$

gdje je:

- površina projekcije svih kamenih blokova na površinu okomitu na strujnice :
 $S_{Ad} = n_{k,usv} \cdot A_d = 234 \cdot 0,18 = 37,98m^2 ;$

- omočena površina rampe :

$$\Omega_r = O \cdot L_r = 3,08 \cdot 111,11 = 308,17 m^2 ;$$

- koeficijent otpora kamenih blokova :

$$C_d = 1,5.$$

Iz odnosa λ_o i λ_k se vidi da dominiraju otpori uslijed kamenih blokova, trenje po dnu je manjeg značaja.

Koeficijent ukupnog otpora:

$$\lambda = \frac{\lambda_k + \lambda_o \cdot (1 - \varepsilon_o)}{1 - \varepsilon_v} = \frac{0,739 + 0,134 \cdot (1 - 0,123)}{1 - 0,243} = 1,133,$$

gdje su faktori ponderacije:

$$\varepsilon_o = \frac{S_{Ad}}{\Omega_r} = \frac{37,98}{308,17} = 0,123$$

$$\varepsilon_v = \frac{n_{k,usv} \cdot \nabla_k}{A \cdot L_r} = \frac{211 \cdot 0,085}{0,735 \cdot 100,0} = 0,243.$$

3) Provjera propusne moći

Brzina toka određuje se iz jednadžbe jednolikog tečenja :

$$V = \sqrt{8 \cdot g \cdot R \cdot I_d / \lambda} = \sqrt{8 \cdot 9,81 \cdot 0,238 \cdot 0,02 / 1,133} = 0,574 m / s.$$

Računski protok

$$Q = V \cdot A = 0,574 \cdot 0,735 = 0,422 m^3 / s$$

je gotovo jednak projektom protoku $Q_{min} = 0,4 m^3 / s$ što znači da je rješenje riblje staze prihvatljivo.

Potrebno je provjeriti uvjet koji zahtijeva Froudov broj manji od 1:

$$Fr = \frac{V^2 \cdot B}{g \cdot A} = \frac{0,547^2 \cdot 2,9}{9,81 \cdot 0,735} = 0,132 < 1,$$

što potvrđuje da je tečenje u mirnom režimu.

4) Provjera brzine u suženjima

U poprečnom profilu čiji proticajni presjek smanjuju 2 kamena bloka, geometrijske karakteristike poprečnog presjeka su:

- Aktivna površina poprečnog presjeka u suženju :

$$A_s = A - 2A_d = 0,735 - 2 \cdot 0,18 = 0,375 m^2$$

- Širina vodnog lica :

$$B_s = B - 2d = 2,9 - 2 \cdot 0,6 = 1,7 m$$

- Brzina toka u suženju :

$$V_s = V \cdot \frac{A}{A_s} = 0,574 \cdot \frac{0,735}{0,375} = 1,13 m/s$$

Provjerava se sljedeći uvjet :

$$Fr = \frac{V_s^2 \cdot B_s}{g \cdot A_s} = \frac{1,13^2 \cdot 1,7}{9,81 \cdot 0,375} = 0,586 < 1,70$$

Kada su svi navedeni hidraulički uvjeti zadovoljeni, pretpostavljene geometrijske karakteristike riblje staze predstavljaju moguće projektno rješenje.

Proračun riblje staze u HEC-RAS - u

Ulazni podaci:

- Duljina riblje staze: 100,0 m
- Nagib: 0,02
- Trapezni poprečni presjek : visina 0,4 m ; dubina vode 0,3 m ; širina dna 2,0 m, nagib pokosa 1:m=1:1,5
- Kameni blokovi: postavljaju se naizmjenice 2 te 1 kameni blok promjera 0,6 m na razmacima 1,0 m visine 0,35m (Slika 15)
- Protok iznosi 0,4 m³/s, a normalna dubina vode 0,3 m

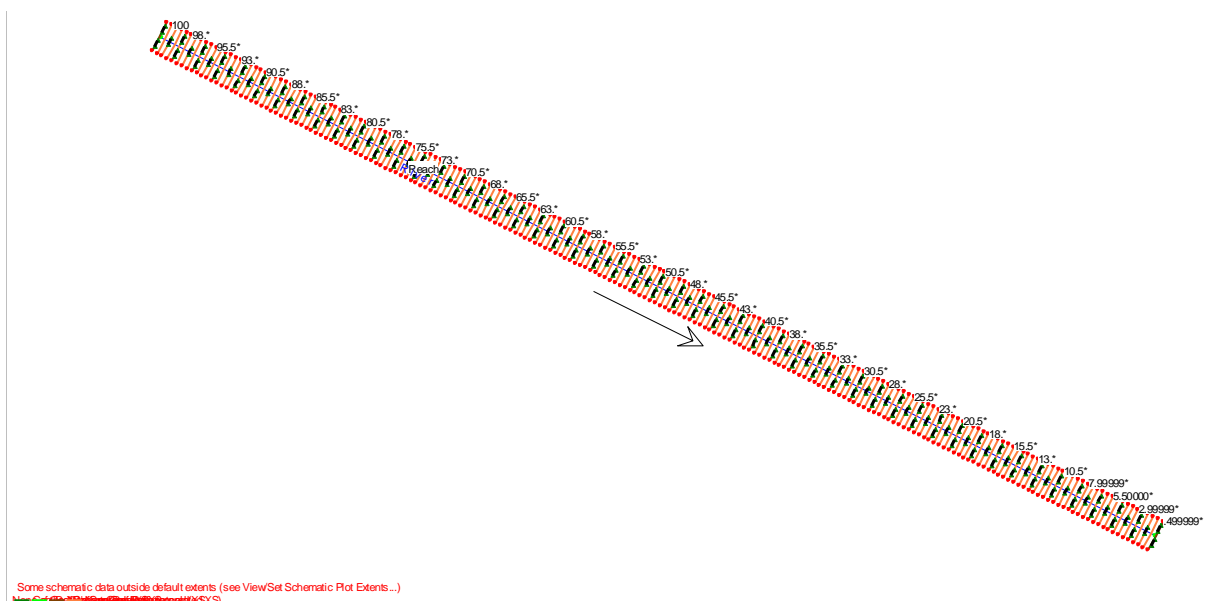

Slika 15. Slaganje kamenih blokova

Izlazni podaci:

- 3-D model riblje staze (Slika 16)
- Promjena protočne površine duž staze
- Promjena vrijednosti Froudovog broja u kontrolnim profilima
- Promjena normalne dubine u pojedinim poprečnim presjecima (Slika 17)
- Omočeni obod ovisno o promjeni normalne dubine
- Promjena brzine u kontrolnim profilima (Slika 18)

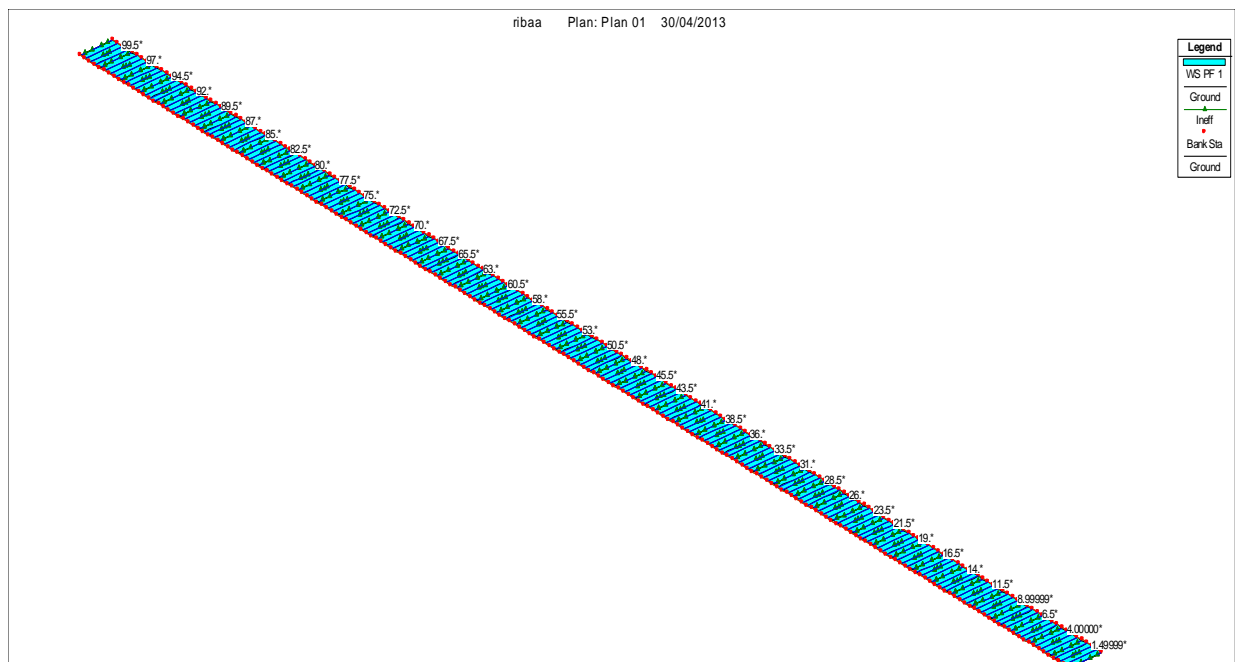

Slika 16. 3-D model riblje staze

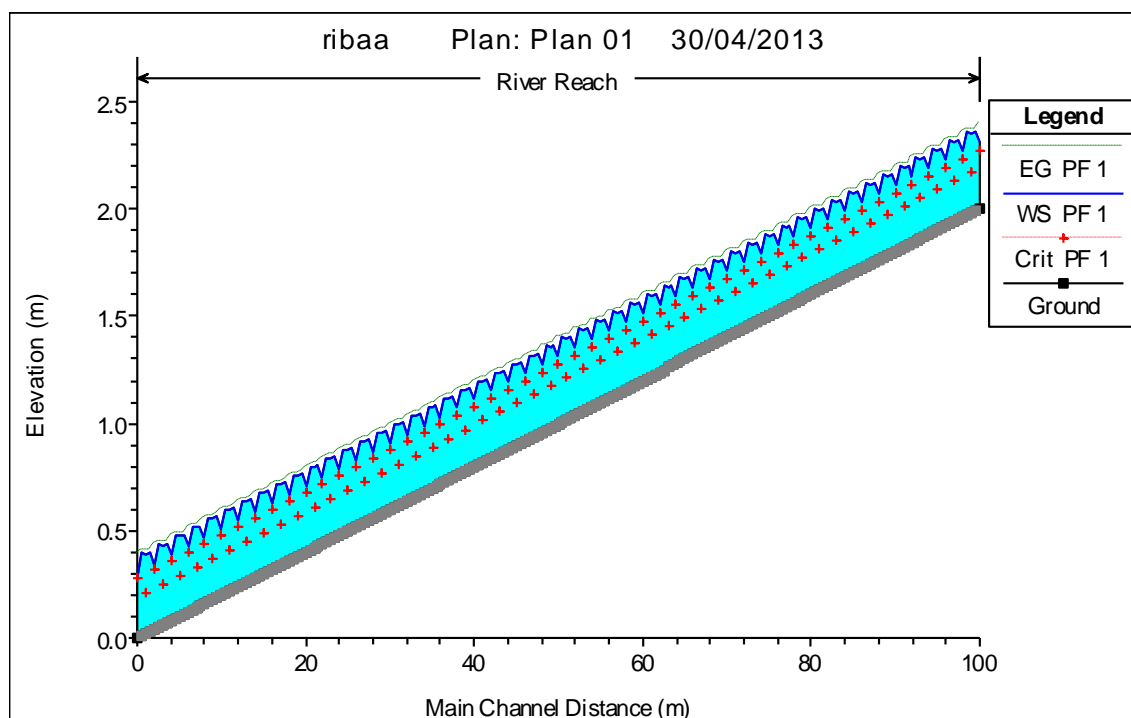

Slika 17. Uzdužni presjek kroz riblju stazu

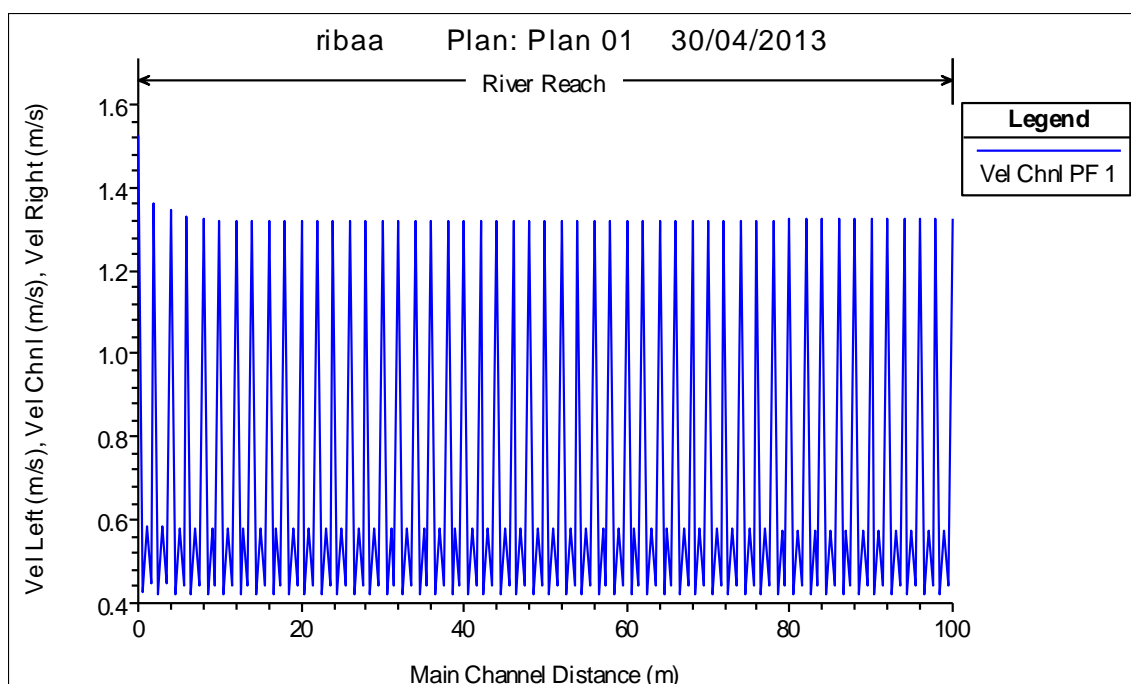

Slika 18. Promjena brzina duž riblje staze

Dobiveni rezultati matematičkim modelom su zadovoljavajući za hidrauličke kriterije tečenja. Kako je vidljivo na slici 18., maksimalne brzine se pojavljuju u suženjima sa dva kamena bloka, iznose $1,33 \text{ m/s}$ što je manje od maksimalno dozvoljene brzine (2 m/s). U presjecima bez blokova brzine tečenja se smanjuju što je bitno za ribe u slučaju potrebnog odmora. Froudov broj ukazuje na mirno tečenje.

4.4. ANALIZA GEOMETRIJSKIH KARAKTERISTIKA RIBLJIH STAZA

Cilj analize je pokazati ovisnost parametara oblikovanja riblje staze o različitim ulaznim podacima te pružiti osnovne podloge za koncipiranje riblje staze. Analiza ribljih staza na temelju hidrauličkih uvjeta tečenja rađena je za različitu geometriju ribljih staza (za različite uzdužne padove i različite širine riblje staze) te za različite projektne protoke i brzine.

Proračun je rađen primarno za male hidroelektrane za koje je predviđen pad vodnog lica između gornje i donje vode od 2 do 6 metara i projektni protok od 100 do 400 l/s. Širina kanala se odabire prema preporuci za pojedine riblje vrste. Za hrvatske slatkovodne riblje vrste preporučena širina kanala je u rasponu od 2 do 4 metra za normalna naizmjenična rebra, a 1 metar za riblju stazu s bazenima. Brzine tečenja pogodne za slatkovodne riblje vrste Hrvatske su između 0,5 m/s i 1,0 m/s.

Proračun je rađen u programu Microsoft Office Excel te je priložen u prilogu radu, a u analizi su prikazani grafički prilozi koji prikazuju osjetljivost parametara oblikovanja ribljih staza, a iz kojih se mogu očitati i podatci za osnovno koncipiranje ribljih staza, ovisno o ulaznim podacima.

4.4.1. RIBLJE STAZE S NORMALNIM NAIZMJENIČNIM REBRA

Prilikom proračuna ovog tipa ribljih staza cilj je proračunati potrebnu visinu i razmak pregrada, kako bi se ostvarile dopuštene brzine tečenja u kanalu. Posebnost riblje staze s naizmjeničnim rebrima je u mogućnosti povećanja nagiba riblje staze do naoko neograničene vrijednosti. Naime za ulazni parametar nagiba staze, širine staze, protoka u njoj te zahtijevane brzine tečenja, dobivaju se kao izlazni rezultat visine i razmaci rebara potrebni da se ostvari tečenje zahtijevanom brzinom. Ubacivanjem ma kako velikog nagiba, dobiti ćemo izlazni rezultat, no ono na što je potrebno obratiti pažnju jest činjenica da povećanjem nagiba kanala riblje staze, povećava se visina pregrade, a time i razmak među njima. Za neki kritični nagib u proračunu zahtijevani razmak pregrada prijeći će ukupnu duljinu riblje staze. Logično je da se takvim oblikovanjem ne može ostvariti režim tečenja pretpostavljen u

proračunu te time račun nije valjan. Da bi se ostvario pretpostavljeni režim tečenja na kanalu treba biti postavljen dovoljan broj naizmjenično pretpostavljenih rebara. Rezultati koji slijede rađeni su za neke karakteristične nagibe ribljih staza koji ne premašuju kritičnu vrijednost. Proračunska shema analize osjetljivosti parametara rađena je u Microsoft Office Excelu te je vidljiva u *Prilogu 1*.

Za maksimalnu dopuštenu brzinu od 1 m/s i minimalnu širinu kanala od 2m, potrebna visina pregrade može se očitati s *Grafa 1* u ovisnosti o padu dna kanala, za pojedine protoke. Razmak takvih pregrada računa se pomoću izraza $\delta = 7\Delta$.

Ovim grafom omogućeno je, na taj način, početno projektiranje riblje staze s naizmjeničnim rebrima za ulazne parametre $v=1$ m/s i $b=2$ m. Ovi ulazni parametri odabrani su za grafički prikaz ovisnosti jer oni daju minimalne zemljane radove i potreban otkup zemljišta pri izvedbi riblje staze pa su zbog toga najisplativiji.

Iz *Grafa 1* vidljiva je također ovisnost visine i razmaka pregrada o protoku.

Porastom protoka s minimalnog promatranog od 100 l/s na maksimalni promatrani od 400 l/s visina potrebne pregrade mijenja se linearno zavisno o nagibu. Za male nagibe od 5 % promjena je s 0,12 m na 0,24 m, a za velike nagibe od 25 % porast potrebne visine je s 0,24 na 0,5 m. Proporcionalno porastu visine pregrade mijenja se i udaljenost među pregradama.

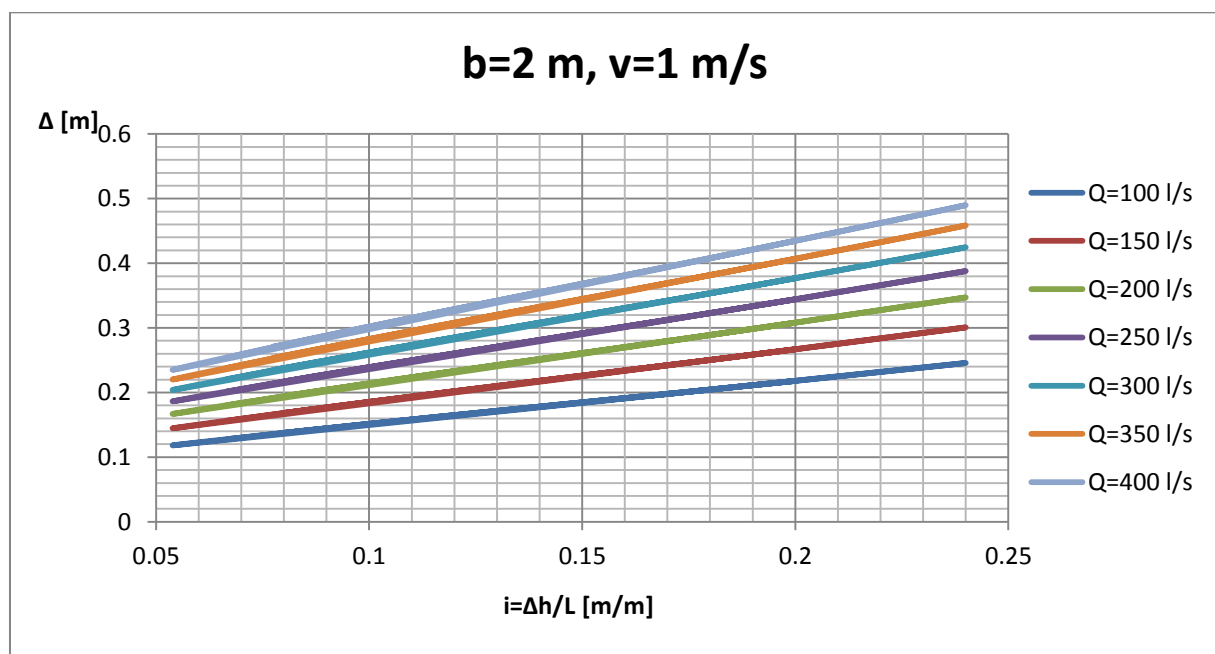

Graf 1. Ovisnost visine pregrade o nagibu za različite protoke

Na potrebnu visinu pregrade, a time i njihov razmak utječu značajno i širina kanala i zahtijevana brzina u kanalu. Utjecaj smanjenja zahtijevane brzine na visinu pregrade prikazan je *Grafom 2*. Prikaz utjecaja dan je za protok $Q=200 \text{ l/s}$ i širinu kanala od 2 m . Može se uočiti da potrebna visina pregrade raste što je zahtijevana brzina manja. Porast je opet manje vidljiv za manje nagibe, a izraženiji za veće nagibe. Za nagib od 5% da bi se ostvarili uvjeti tečenja $v=0,5 \text{ m/s}$ u odnosu na $v=1 \text{ m/s}$ visina pregrade mora sa $0,16$ porasti na $0,48 \text{ m}$, a za nagib 25% sa $0,36$ na 1 m .

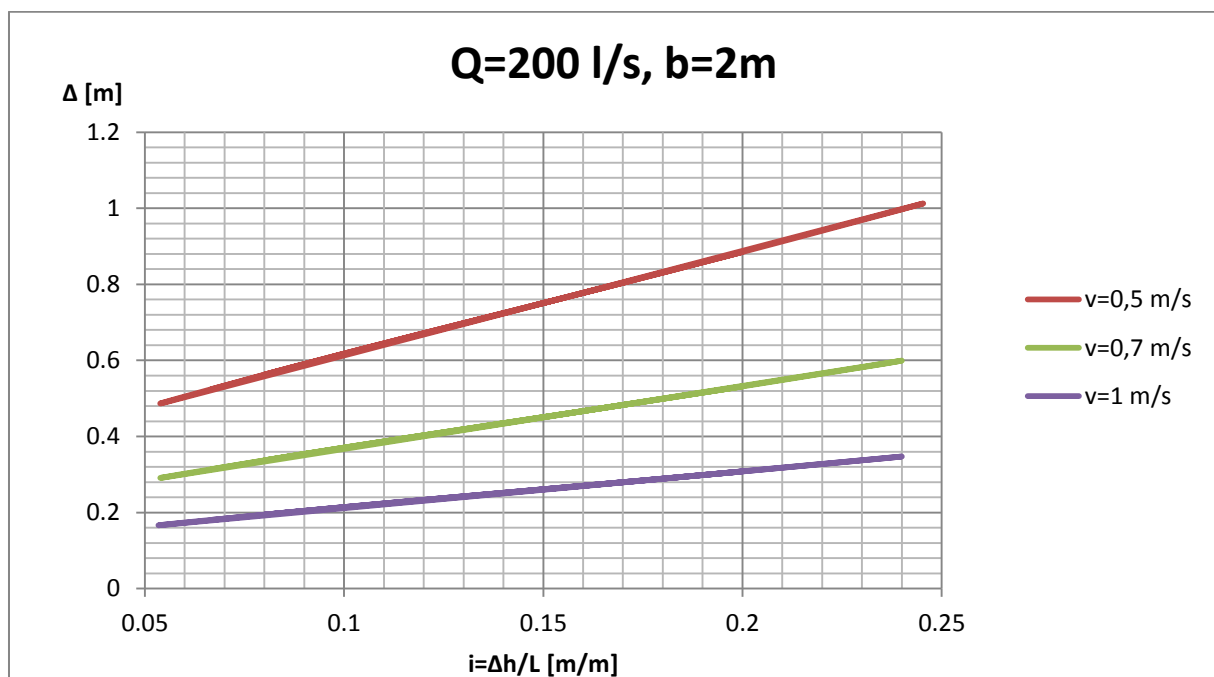

Graf 2. Ovisnost visine pregrade o nagibu i brzini za $Q=200 \text{ l/s}$ i $b=2 \text{ m}$

Utjecaj proširenja kanala, na visinu i razmak pregrada u ribljoj stazi prikazan je *Grafom 3*. Može se uočiti da se povećanjem širine kanala smanjuje visina potrebne pregrade. Prikaz utjecaja dan je za protok $Q=200 \text{ l/s}$ i brzinu $v=1 \text{ m/s}$. Iako su promjene uočljive, one nisu značajne. Promjenom širine kanala sa 2 m na 4 m potrebna visina pregrade smanjuje se svega 10 -ak centimetara.

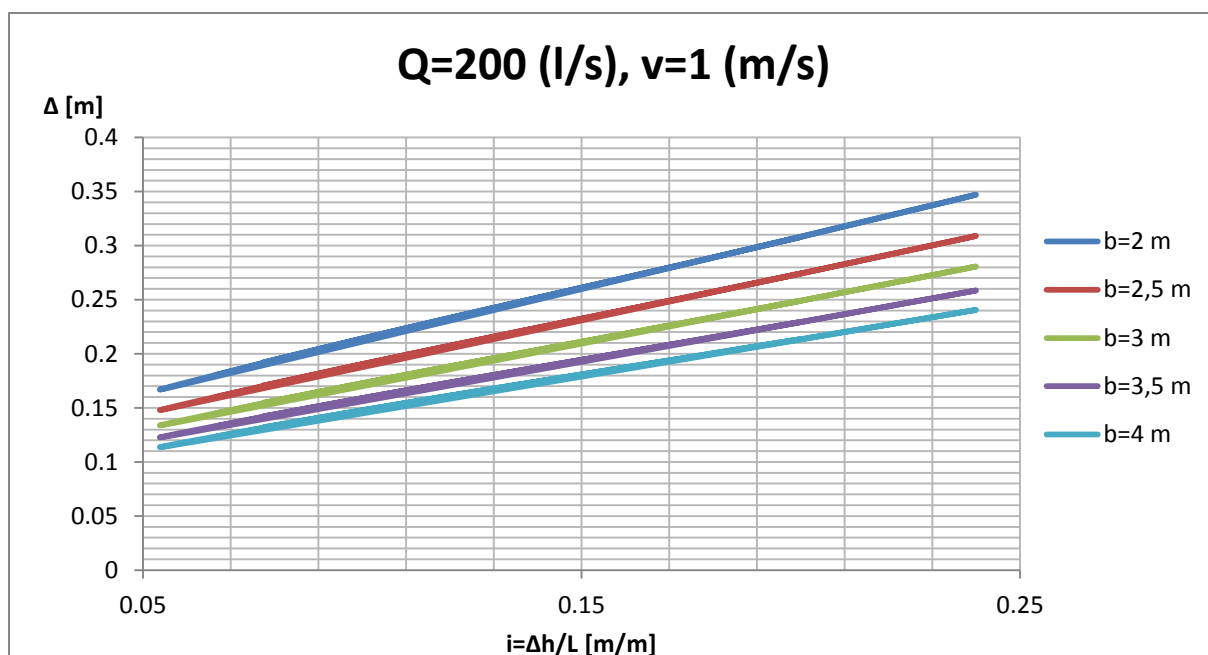

Graf 3. Ovisnost visine pregrade o padu dna kanala, za pojedine brzine i protok $Q=200\text{ l/s}$ i pad dna kanala $b=2\text{ m}$

Dobiveni rezultati analize osjetljivosti su logični jer se pregradom ostvaruje disipacija energije pa je za ostvarenje manje brzine tečenja potrebna veća disipacija energije (viša pregrada), a za povećanu širinu kanala i zadržavanje prethodno definirane brzine ($v=1\text{ m/s}$) potrebna je manja disipacija energije preko pregrada (niže pregrade).

4.4.2. RIBLJE STAZE S BAZENIMA

Prilikom proračuna ovog tipa ribljih staza cilj je za projektni protok, pad vodnog lica, određenu širinu kanala i brzinu tečenja u kanalu, ovisno o potrebama ribljih vrsta odrediti potreban broj bazena, njihovu duljinu te ukupnu duljinu na ovaj način projektirane riblje staze. U presjecima sa pregradama je ostvarena dopuštena brzina tečenja, dok se u prostoru staze bez pregrade stvaraju mirnije zone, čime je ribama omogućeno da u slučaju potrebe imaju prostor za odmor.

Na temelju proračunske sheme rađene u Excelu, a vidljive u *Prilogu 2*, dobiven je grafički prikaz ovisnosti duljine riblje staze o zadanom padu vodnog lica, za određene protoke. Prikaz ovisnosti dan je *Grafom 4*. Iz ovog grafa, može se direktno očitati, za zadani, projektni protok i zadani pad vodnog lica, potrebna duljina riblje staze. Osim toga, može se uočiti ovisnost duljine riblje staze o povećanju protoka. Potrebna duljina riblje staze, logično, raste povećanjem protoka, a povećanje potrebne duljine jače je izraženo za veći pad vodnog lica. Povećanjem protoka sa 100 l/s na 400 l/s duljina riblje staze povećava se 40 m za pad vodnog lica od 2 m, a 130 m za pad vodnog lica od 6 m.

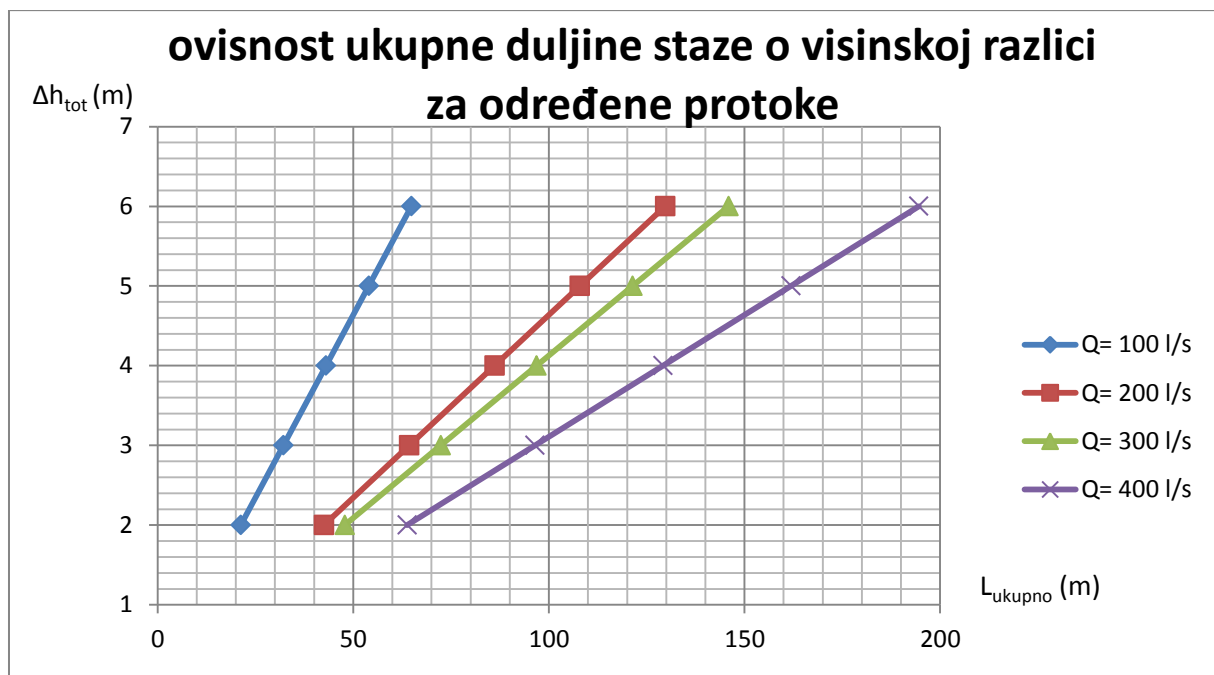

Graf 4. Ovisnost duljine riblje staze o zadanom padu vodnog lica, za određene protoke

Također je dobiven grafički prikaz ovisnosti duljine jednog bazena o protoku koji je prikazan *Grafom 5*. Korištenjem ovog grafa može se za neki protok očitati potrebna duljina pojedinog bazena. Povećanjem protoka povećava se i potrebna duljina bazena.

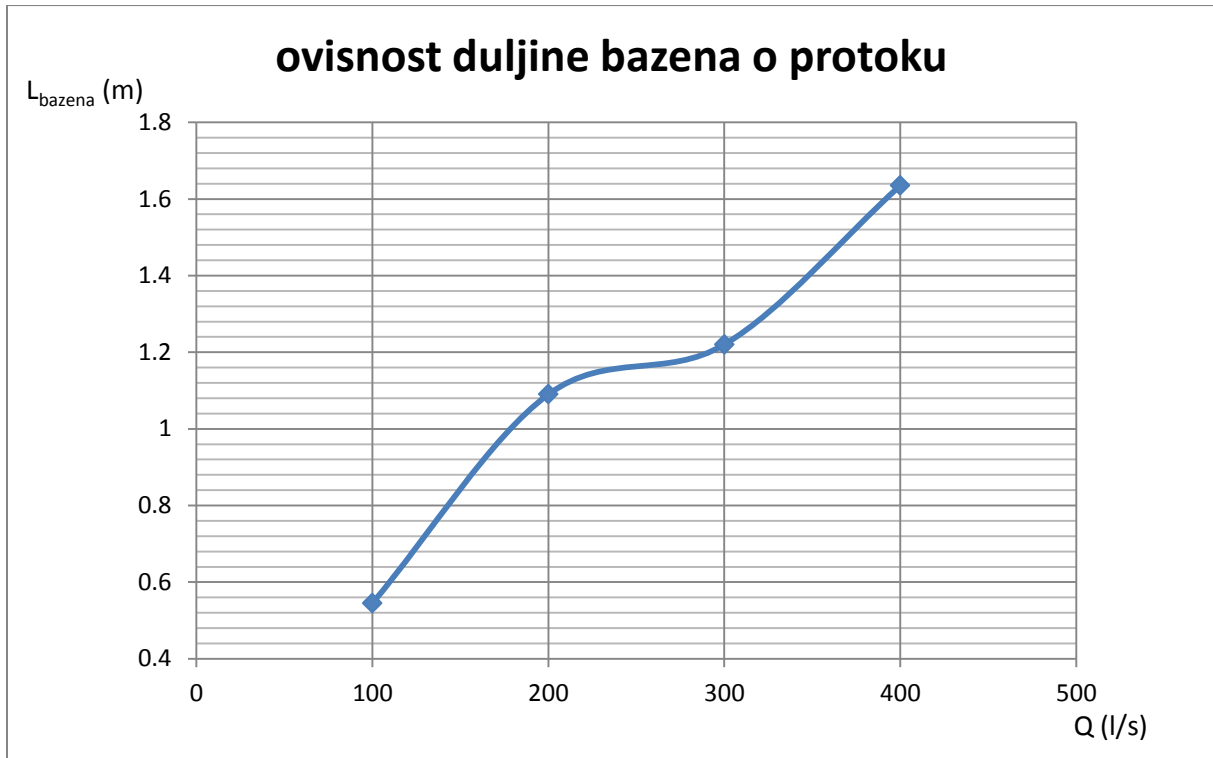

Graf 5. Ovisnost duljine pojedinog bazena o protoku

Kombinacijom *Grafa 4* i *Grafa 5* moguće je riješiti problem koncipiranja riblje staze s bazenima. Iz *Grafa 4* se za zadani, projektni protok i zadani pad vodnog lica, očitava potrebna duljina riblje staze. Potom se iz *Grafa 5* za projektni protok očitava potrebna duljina pojedinog bazena. Broj bazena dobije se dijeljenjem ukupne duljine riblje staze s duljinom pojedinog bazena. Time je određen tlocrtni izgled riblje staze.

4.4.3. PRIRODNE RIBLJE STAZE

Prilikom proračuna ovog tipa ribljih staza ulazni podaci su poprečni profil, protok i dimenzije kamenih blokova, a kao rezultat proračuna dobiva se broj kamenih blokova, duljina i brzina tečenja. Ovisno o rasporedu kamenih blokova variraju brzine tečenja duž riblje staze. U suženim presjecima (profili sa kamenim blokovima) vrijednosti brzina tečenja su zadovoljavajuće, tj. manje su od maksimalno dopuštene. Vrijednosti brzina u profilima bez kamenih blokova smanjene su, u odnosu na vrijednosti brzine tečenja u suženim presjecima, a to je bitno za odmor ribljih vrsta prilikom migriranja. Zbog velikog broja međusobno zavisnih, ulaznih parametara teško je pokazati analizu osjetljivosti parametara, osnovni koncept analize osjetljivosti rađen je pomoću proračunske sheme u Excelu koja je dana u *Prilogu 3* i na osnovu koje su dobiveni sljedeći grafovi (Graf 6 i Graf 7)

Iz *Grafa 6* vidljiva je ovisnost potrebne duljine riblje staze o nagibu. Ukoliko je nagib blaži, veća je duljina. Najveće duljine dobivaju se za pad od 1,35 %. Za ovaj nagib duljine se mijenjaju od 148,15 m do 444,44 m ovisno o padu vodnog lica između gornje i donje vode.

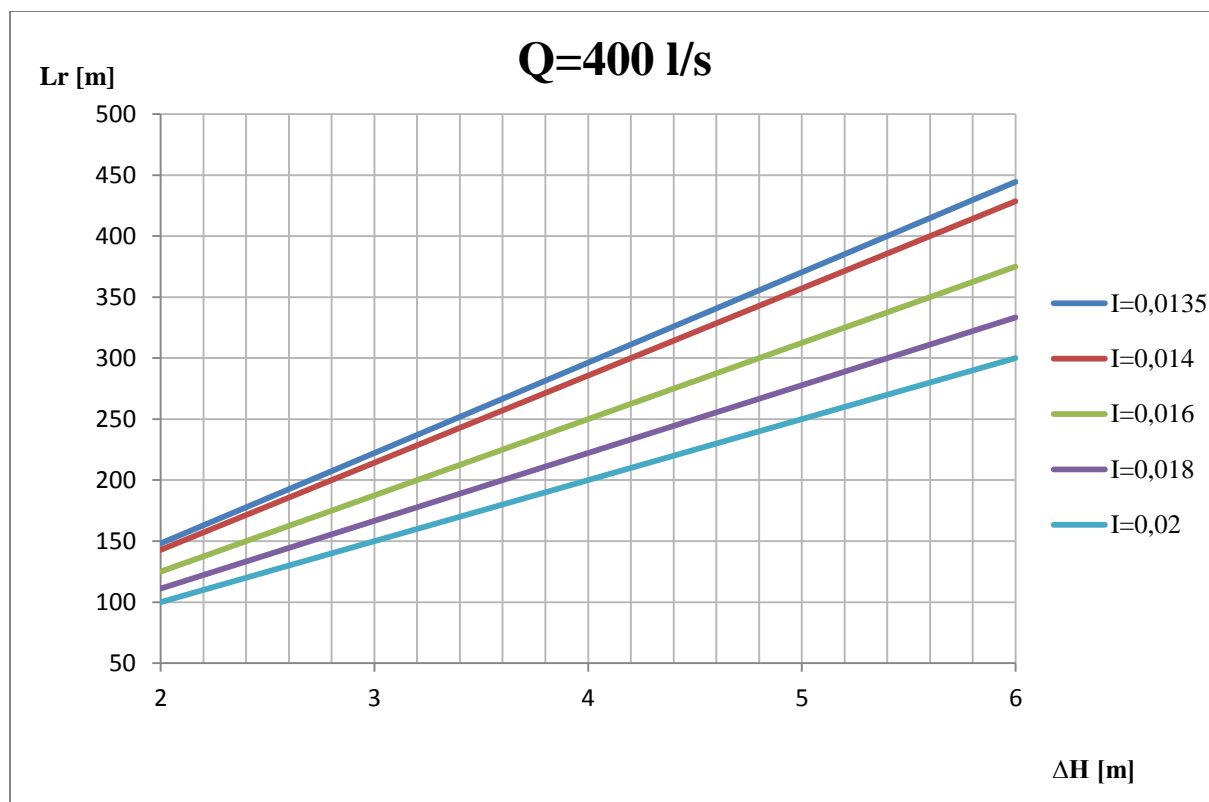

Graf 6. Ovisnost duljine o nagibu i padu vodnog lica

Promjenom duljine staze mijenja se i potreban broj kamenih blokova. Na *Grafu 7* prikazana je ovisnost potrebnog broja blokova za duljine ribljih staza u rasponu od 100 do 300 m, pri nagibu od 2%. Iz *Grafa 7* vidljivo je daje za istu duljinu riblje staze, a manji promjer kamenog bloka i manji njihov međusobni razmak, potreban veći broj kamenih blokova. Ukoliko se analizira promjena broja kamenih blokova istih dimenzija i razmaka ovisno o duljini riblje staze, vidi se da je za dužu stazu potreban veći broj kamenih blokova istog tipa. Tako je za npr. $d=0,6$ m i $a=1,0$ m te 33,33% dužu stazu potrebno 33,33% više kamenih blokova.

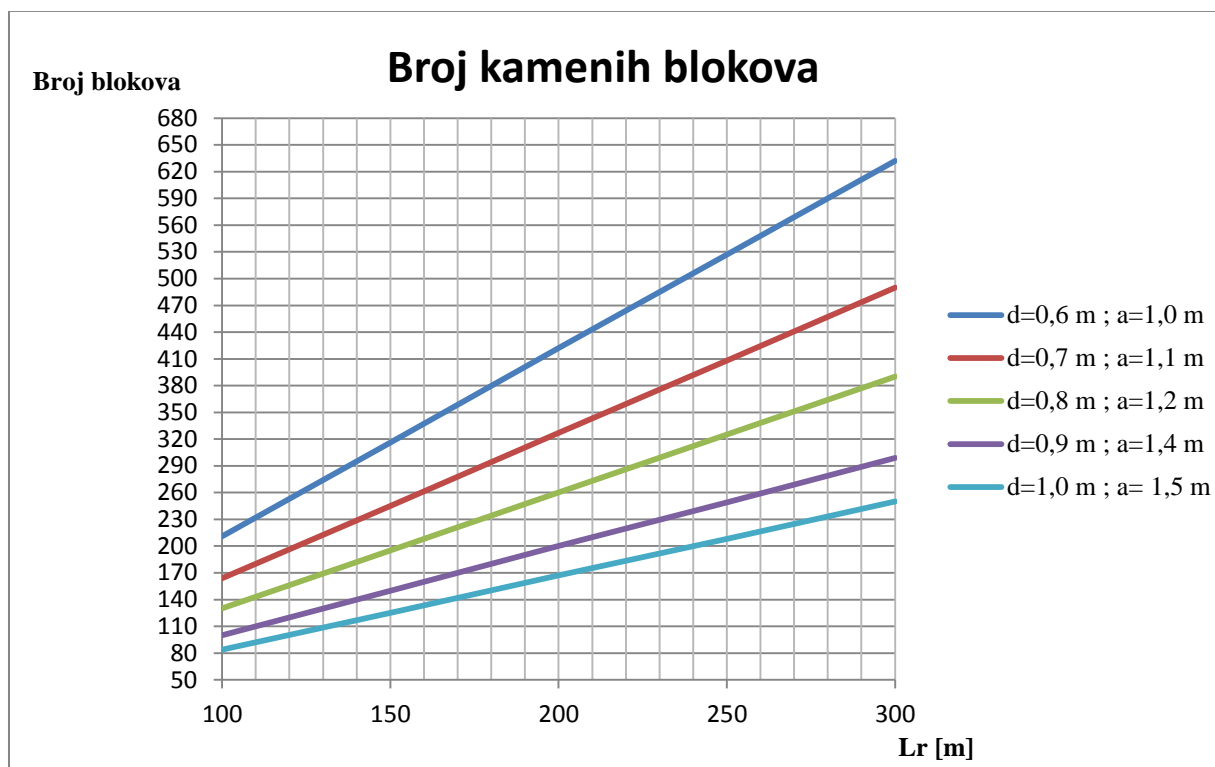

Graf 7. Broj kamenih blokova ovisno o duljini riblje staze i dimenzijama kamenih blokova

5. RASPRAVA REZULTATA

Sva tri tipa ribljih staza za koje su rađeni proračuni, kao što je spomenuto, odgovaraju hrvatskim slatkovodnim ribljim vrstama tj. njihovom plivanju vijuganjem. No, svaki od navedenih tipova ističe se nekim prednostima i manama u odnosu na ostale prikazane tipove. Provedenim hidrauličkim proračunima i usporedbom dobivenih rezultata po tipovima promatranih ribljih staza proizašli su sljedeći zaključci:

- Tip ribljih staza s normalnim naizmjeničnim rebrima je najefikasniji jer se njime može premostiti zahtijevani pad vodnog lica pod najvećim nagibom, tj. najmanjom duljinom kanala. Proračun ovakvog tipa jednostavan je i brz, a jednostavno je i njegovo oblikovanje. Moguća mala duljina kanala ovog tipa staze omogućuje i pravilno pozicioniranje ulaza u riblju stazu. Kao što je već spomenuto, da bi ulaz u riblju stazu bio ispravno pozicioniran, on treba biti što bliže pregradi na vodotoku, a zbog toga je pogodno imati malu duljinu riblje staze, čiji se početak tj. kraj može postaviti blizu pregrade.
- Tip ribljih staza s bazenima najpogodnije je oblikovan za migraciju ribljih vrsta. Ribljim vrstama lakše je u dijelovima savladavati male visinske razlike između bazena, nego u jednom dijelu cijelu visinsku razliku. Također, prednost je i što ribe dobivaju prostor za odmor, jer se brzina istjecanja kroz otvor prilagođava brzini koju riba može podnijeti, dok je u bazenima brzina puno manja, te je tako bazen pogodno mjesto za odmor riba. Osim toga, ovaj tip odlikuje se jednostavnim proračunom i zavisnosti parametara oblikovanja takvima da je moguće njegovo koncipiranje na osnovu prikazanih dijagrama. Potrebna duljina ovog tipa riblje staze veća je nego kod ribljih staza s naizmjeničnim rebrima, ali znatno manja nego kod prirodnog tipa ribljih staza. Nedostatak veće duljine staze može biti riješen tako da se staza konstruira tako da mijenja smjer za 180°. Također, ovaj tip staza ima i manju potrebnu širinu od ostalih tipova.

- Prirodni tip ribljih staza zahtjeva najveću potrebnu duljinu riblje staze da bi se ostvarili zahtijevani uvjeti tečenja, a time i najveće troškove pri izvedbi. Potreba za velikom duljinom riblje staze rezultira, iz spomenutih razloga, problemima pri oblikovanju ulaza u riblju stazu. Ono što je svakako prednost riblje staze prirodnog tipa je njen prirodni izgled. Pod prirodnim izgledom podrazumijeva se u ovom slučaju da je takav tip riblje staze prirodni nastavak starog korita rijeke tj. ovakav tip riblje staze građen je od prirodnog materijala starog riječnog korita te kamenih blokova. Osim ribljim vrstama prirodnog staništa, ovaj tip pruža i estetski najprihvatljiviji oblik riblje staze. Tip prirodnih ribljih staza zbog navedenih prednosti u trendu je suvremenog uređenja vodotoka.

U ovom radu nije rađena ekonomska analiza prikazanih rješenja, koja u praktičnoj primjeni može imati značajnu ulogu.

6. ZAKLJUČAK

Riblje staze su važne konstrukcije koje omogućuju istovremeno korištenja vodotoka u energetske svrhe i očuvanja raznolikosti ribljeg svijeta u vodotocima.

Projektiranje ribljih staza odgovoran je posao jer o njemu ovisi uspješnost riblje staze. Kao što se da vidjeti i u ovom radu, projektiranje je detaljnije koncipirano i jednostavnije za tehničke tipove ribljih staza, a manje razrađeno i složenije za prirodne tipove ribljih staza. Projektiranje ribljih staza u Hrvatskoj nema dugu tradiciju i počelo je prije tek nekoliko godina. Zbog toga se pri projektiranju ribljih staza treba osloniti na već postojeće preporuke razvijene u nekim drugim zemljama i modificirane prema potrebama ribljih vrsta u Hrvatskoj, a kao podloga pri tom projektiranju može poslužiti i ovaj rad. Uspješnosti tako projektirane i izvedene riblje staze treba kontrolirati u njenoj uporabi. Mjerenjima na terenu prilikom kojih se bilježi broj organizama koji prolaze kroz riblju stazu ocjenjuje se uspješnost riblje staze. Ovako usvojena saznanja koriste se pri projektiranju novih ribljih staza koje se na taj način usavršavaju za dano područje i riblje vrste. Pred Hrvatskom je dug period osmišljavanja i prilagođavanja ribljih staza za svoje područje i riblje vrste, no on se može prebroditi samo već spomenutom integriranim pristupom projektiranja i mjerenja uspješnosti ribljih staza.

Uspješnim projektiranjem ostvarit će se iskorištavanje vodotoka u energetske svrhe, bez narušavanja živog svijeta u vodi, što je cilj svake zemlje koja teži zaštiti svojih prirodnih bogatstava, ali i ekonomskom napretku i razvitku.

7. LITERATURA

1. Kuspilić, N., Pršić, M., Ocvirk, E., *Hidrotehničke građevine*, Sveučilište u Zagrebu, Građevinski fakultet, 2012.
2. EIHP, *Male hidroelektrane*, South East Europe Transnational Cooperation Programme, 2010.
3. Hecker, G., Amaral, S., Allen, G., *The Science Behind a Fish Friendly Turbine*, National Conference on Engineering and Ecohydrology for Fish Passage, 2012.
4. *Program iskorištenja slobodnog hidropotencijala u Republici Hrvatskoj*, Hrvatska komora inženjera građevinarstva, 2012.
5. Hrvatsko društvo za biološka istraživanja, HDBI, *Ribe Hrvatske*, <http://www.ribe-hrvatske.com/index.php>
6. Project Factsheet: *Highland Lake Fish Passage Restoration*, Westbrook Maine, 2006
7. FAO, *Fish passes – Design, dimensions and monitoring*, FAO, 2002.
8. Kapitzke, R., *Culvert Fishway, Planning and Design Guidelines*, James Cook University, 2004.
9. Katopodis, C., *Introduction to fishway design*, University CrescentWinnipeg, Manitoba Canada, 1992.
10. Kamula, R., Barthel, J., *Effects of modification on the hydraulics of Denil fishway*, Boreal environment research, 2000.
11. Agroskin, I., *Hidraulika*, Tehnička knjiga Zagreb, 1964.

12. Mustionjoki cultural river restoration, <http://mustionjoki.blogspot.com>
13. Jovanović, M., *Riblje staze u sklopu naturalnog uređenja malih vodotoka*, Građevinski fakultet Univerziteta u Beogradu, 2011.
14. Beach, M.H., *Fishpass design - criteria for the design and approval of fish passes and other structures to facilitate the passage of migratory fishes in rivers*, Ministry of Agriculture, 1984.
15. Larinier, M., Travade, F., *Downstream migration: Problems and facilities*, Institut de Mécanique des Fluides Toulouse France, 2002.
16. *Fish Passage Technologies: Protection at Hydropower Facilities*, OTA-ENV-641 (Washington, DC: U.S. Government Printing Office, September 1995).
17. US Army corps of engineers, *HEC-RAS Tehnical manual*, US Army, 2010.
18. Chow, *Open channel Hydraulics*, 1959.

8. SAŽETAK

Mirijana Prša, Matea Rebrina i Ivana Srednoselec

ANALIZA GEOMETRIJSKIH KARAKTERISTIKA RIBLJIH STAZA U OVISNOSTI O HIDRAULIČKIM UVIJETIMA TEČENJA

Ideja za ovaj rad potaknuta je potrebom za stvaranje sustavnog projektiranja ribljih staza u Hrvatskoj. Riblje staze trebale bi se u skoroj budućnosti projektirati i izvoditi u Hrvatskoj u većem broju zbog planirane izgradnje većeg broja malih hidroelektrana. Cilj ovog rada je osigurati podloge za projektiranje ribljih staza za koje je ustanovljeno da najbolje odgovaraju migracijama hrvatskih slatkovodnih vrsta.

U svrhu toga rađena je analiza geometrijskih karakteristika 3 tipa ribljih staza za propisane hidrauličke uvjete tečenja. Za propisani potrebni protok, dimenzije staze i dopuštene brzine, uz uvjet da su pregrade postavljene tako da ih riblje vrste ne moraju savladavati preskakanjem, analizirana su 2 tehnička tipa ribljih staza (staze s naizmjenično postavljenim rebrima, staze s bazenima) i prirodne riblje staze.

Iz tih analiza su proizašli dijagrami ovisnosti pojedinih parametara koji se mogu koristiti za očitavanje podataka u početnim fazama projektiranja ribljih staza. Također su pokazane prednosti i nedostaci pojedinog tipa riblje staze u odnosu na ostale. Ustanovljeno je da se tehničkim ribljim stazama mogu postići traženi uvjeti tečenja na jednostavniji i isplativiji način nego s prirodnim ribljim stazama. Tako staze s naizmjeničnim rebrima zahtijevaju najmanju duljinu kanala riblje staze, staze s bazenima nešto veću, a prirodne riblje staze znatno veću duljinu kanala.

Također, u radu je dan pregled osnovnih tipova ribljih staza s njihovim karakteristikama. Dane su i smjernice za oblikovanje ulaza i izlaza iz staze te oblikovanja dna, kao važnih dijelova u pitanju funkcionalnosti riblje staze.

Ključne riječi: Riblje staze, male hidroelektrane, hidraulički proračun

9. SUMMARY

Mirijana Prša, Matea Rebrina, Ivana Srednoselec

ANALYSIS OF GEOMETRICAL CHARACTERISTICS OF FISH PASSES DEPENDING ON HYDRAULIC FLOW CONDITIONS

The idea for this work was encouraged by the need to create a systematic design of fish passes in Croatia. In the near future, fish passes should be designed in Croatia in greater number due to the planned building of small hydro power plants. The purpose of this paper is to provide a basis for the design of fish passes that were found to be the most adjusted for migration of Croatian freshwater species.

For this purpose, the analysis of geometric characteristics of 3 types of fish passes was performed, for required hydraulic flow conditions. Two technical types of fish passes (fish pass with alternately placed barriers, pool fish passes) and natural fish passes were analyzed according to a required flow rate, dimensions of a pass and the speed limit. Barriers in these types of fish passes were placed so that fish species would not have to cope with jumping.

These analyses were resulted in dependency charts of certain parameters that can be used to read the data in the initial stages of fish passes design. There were also presented the advantages and disadvantages of each type of fish passes over others. It was found that the technical fish passes can achieve the required flow conditions in a simpler and more cost-effective way than the natural fish ladders. Therefore, passes with alternately placed barriers require a minimum length of the fish pass channels, pool passes require slightly higher, and natural fish passes significantly higher length of the channel.

Additionally, the paper gives an overview of the main types of fish passes and their characteristics. Moreover, guidelines are provided for the design of the fish pass entrance and exit as well as the design of the bottom, all of them being important parts in terms of functionality of fish passes.

Key words: Fish passes, small hydro power plants, hydraulic calculation

10. PRILOZI

- Prilog 1- proračunska shema ribljih staza s normalnim naizmjenično postavljenim rebrima
- Prilog 2 – proračunska shema ribljih staza sa bazenima
- Prilog 3 – proračunska shema prirodnih ribljih staza

PRILOG 1

**– PRORAČUNSKA SHEMA RIBLJIH STAZA S NORMALNIM
NAIZMJENIČNO POSTAVLJENIM REBRIMA**

PRILOG BROJ 1

Tip riblje staze:		normalna naizmjenična rebra
M	N	
0.077	18	

Q (m ³ /s)	v (m/s)	b (m)	pret. Δh	pretp. L
0.1	0.7	2	2	25
0.15	0.7	2	2	25
0.2	0.7	2	2	25
0.25	0.7	2	2	25
0.3	0.7	2	2	25
0.35	0.7	2	2	25
0.4	0.7	2	2	25
0.1	0.7	2	3	25
0.15	0.7	2	3	25
0.2	0.7	2	3	25
0.25	0.7	2	3	25
0.3	0.7	2	3	25
0.35	0.7	2	3	25
0.4	0.7	2	3	25
0.1	0.7	2	4	25
0.15	0.7	2	4	25
0.2	0.7	2	4	25
0.25	0.7	2	4	25
0.3	0.7	2	4	25
0.35	0.7	2	4	25
0.4	0.7	2	4	25
0.1	0.7	2	5	25
0.15	0.7	2	5	25
0.2	0.7	2	5	25
0.25	0.7	2	5	25
0.3	0.7	2	5	25
0.35	0.7	2	5	25
0.4	0.7	2	5	25
0.1	0.7	2	6	25
0.15	0.7	2	6	25
0.2	0.7	2	6	25
0.25	0.7	2	6	25
0.3	0.7	2	6	25
0.35	0.7	2	6	25
0.4	0.7	2	6	25
0.1	0.7	2.5	2	25
0.15	0.7	2.5	2	25
0.2	0.7	2.5	2	25
0.25	0.7	2.5	2	25

$\omega = \frac{Q}{v}$	$h = \frac{\omega}{b}$	$\chi = b + 2h$	$\frac{\omega^2}{\chi}$	$\Pi_k = \frac{v^2}{gh}$	$\sqrt{\Pi_k}$	$i = \frac{\Delta h}{L}$	$\Delta = \frac{8g \cdot \omega^2 - M + 2i^2}{Q^2 \cdot \chi - N \log i} \cdot h \cdot \frac{\chi}{b} \cdot \sqrt{\Pi_k}$	$\delta = 7\Delta$	uk.Dubina
0.142857	0.071429	2.142857	0.009524	0.699286	0.836233	0.08	0.238625667	1.67038	0.310054
0.214286	0.107143	2.214286	0.020737	0.466191	0.682782	0.08	0.292107027	2.044749	0.39925
0.285714	0.142857	2.285714	0.035714	0.349643	0.591306	0.08	0.337124627	2.359872	0.479982
0.357143	0.178571	2.357143	0.054113	0.279715	0.52888	0.08	0.376725033	2.637075	0.555296
0.428571	0.214286	2.428571	0.07563	0.233095	0.4828	0.08	0.412471537	2.887301	0.626757
0.5	0.25	2.5	0.1	0.199796	0.446986	0.08	0.445293287	3.117053	0.695293
0.571429	0.285714	2.571429	0.126984	0.174822	0.418117	0.08	0.475795991	3.330572	0.76151
0.142857	0.071429	2.142857	0.009524	0.699286	0.836233	0.12	0.285188746	1.996321	0.356617
0.214286	0.107143	2.214286	0.020737	0.466191	0.682782	0.12	0.349144477	2.444011	0.456287
0.285714	0.142857	2.285714	0.035714	0.349643	0.591306	0.12	0.402996838	2.820978	0.545854
0.357143	0.178571	2.357143	0.054113	0.279715	0.52888	0.12	0.450384743	3.152693	0.628956
0.428571	0.214286	2.428571	0.07563	0.233095	0.4828	0.12	0.493175222	3.452227	0.707461
0.5	0.25	2.5	0.1	0.199796	0.446986	0.12	0.532477831	3.727345	0.782478
0.571429	0.285714	2.571429	0.126984	0.174822	0.418117	0.12	0.569015796	3.983111	0.85473
0.142857	0.071429	2.142857	0.009524	0.699286	0.836233	0.16	0.330317454	2.312222	0.401746
0.214286	0.107143	2.214286	0.020737	0.466191	0.682782	0.16	0.404408479	2.830859	0.511551
0.285714	0.142857	2.285714	0.035714	0.349643	0.591306	0.16	0.466801953	3.267614	0.609659
0.357143	0.178571	2.357143	0.054113	0.279715	0.52888	0.16	0.521711799	3.651983	0.700283
0.428571	0.214286	2.428571	0.07563	0.233095	0.4828	0.16	0.571299984	3.9991	0.785586
0.5	0.25	2.5	0.1	0.199796	0.446986	0.16	0.616851295	4.317959	0.866851
0.571429	0.285714	2.571429	0.126984	0.174822	0.418117	0.16	0.659203146	4.614422	0.944917
0.142857	0.071429	2.142857	0.009524	0.699286	0.836233	0.2	0.376197597	2.633383	0.447626
0.214286	0.107143	2.214286	0.020737	0.466191	0.682782	0.2	0.460583064	3.224081	0.567726
0.285714	0.142857	2.285714	0.035714	0.349643	0.591306	0.2	0.531647279	3.721531	0.674504
0.357143	0.178571	2.357143	0.054113	0.279715	0.52888	0.2	0.594189277	4.159325	0.772761
0.428571	0.214286	2.428571	0.07563	0.233095	0.4828	0.2	0.650671204	4.554698	0.864957
0.5	0.25	2.5	0.1	0.199796	0.446986	0.2	0.702556217	4.917894	0.952556
0.571429	0.285714	2.571429	0.126984	0.174822	0.418117	0.2	0.750797987	5.255586	1.036512
0.142857	0.071429	2.142857	0.009524	0.699286	0.836233	0.24	0.424167974	2.969176	0.495597
0.214286	0.107143	2.214286	0.020737	0.466191	0.682782	0.24	0.519310003	3.63517	0.626453
0.285714	0.142857	2.285714	0.035714	0.349643	0.591306	0.24	0.599430978	4.196017	0.742288
0.357143	0.178571	2.357143	0.054113	0.279715	0.52888	0.24	0.669942083	4.689595	0.848514
0.428571	0.214286	2.428571	0.07563	0.233095	0.4828	0.24	0.733619549	5.135337	0.947905
0.5	0.25	2.5	0.1	0.199796	0.446986	0.24	0.792113194	5.544792	1.042113
0.571429	0.285714	2.571429	0.126984	0.174822	0.418117	0.24	0.846498358	5.925489	1.132213
0.142857	0.057143	2.614286	0.007806	0.874108	0.934937	0.08	0.212717351	1.489021	0.26986
0.214286	0.085714	2.671429	0.017189	0.582739	0.763373	0.08	0.260418201	1.822927	0.346132
0.285714	0.114286	2.728571	0.029918	0.437054	0.661101	0.08	0.300582312	2.104076	0.414868
0.357143	0.142857	2.785714	0.045788	0.349643	0.591306	0.08	0.33592403	2.351468	0.478781

PRILOG BROJ 1

Tip riblje staze:		normalna naizmjenična rebra
M	N	
0.077	18	

Q (m ³ /s)	v (m/s)	b (m)	pret. Δh	pretp. L
0.3	0.7	2.5	2	25
0.35	0.7	2.5	2	25
0.4	0.7	2.5	2	25
0.1	0.7	2.5	3	25
0.15	0.7	2.5	3	25
0.2	0.7	2.5	3	25
0.25	0.7	2.5	3	25
0.3	0.7	2.5	3	25
0.35	0.7	2.5	3	25
0.4	0.7	2.5	3	25
0.1	0.7	2.5	4	25
0.15	0.7	2.5	4	25
0.2	0.7	2.5	4	25
0.25	0.7	2.5	4	25
0.3	0.7	2.5	4	25
0.35	0.7	2.5	4	25
0.4	0.7	2.5	4	25
0.1	0.7	2.5	5	25
0.15	0.7	2.5	5	25
0.2	0.7	2.5	5	25
0.25	0.7	2.5	5	25
0.3	0.7	2.5	5	25
0.35	0.7	2.5	5	25
0.4	0.7	2.5	5	25
0.1	0.7	2.5	6	25
0.15	0.7	2.5	6	25
0.2	0.7	2.5	6	25
0.25	0.7	2.5	6	25
0.3	0.7	2.5	6	25
0.35	0.7	2.5	6	25
0.4	0.7	2.5	6	25
0.1	0.7	3	2	25
0.15	0.7	3	2	25
0.2	0.7	3	2	25
0.25	0.7	3	2	25
0.3	0.7	3	2	25
0.35	0.7	3	2	25
0.4	0.7	3	2	25
0.1	0.7	3	3	25

$\omega = \frac{Q}{v}$	$h = \frac{\omega}{b}$	$\chi = b + 2h$	$\frac{\omega^2}{\chi}$	$\Pi_k = \frac{v^2}{gh}$	$\sqrt{\Pi_k}$	$i = \frac{\Delta h}{L}$	$\Delta = \frac{8g \cdot \omega^2 - M + 2i^2}{Q^2 \cdot \frac{\chi}{-N \log i} \cdot h \cdot \frac{\chi}{b} \cdot \sqrt{\Pi_k}}$	$\delta = 7\Delta$	uk.Dubina
0.428571	0.171429	2.842857	0.064609	0.291369	0.539786	0.08	0.36783603	2.574852	0.539265
0.5	0.2	2.9	0.086207	0.249745	0.499745	0.08	0.397145972	2.780022	0.597146
0.571429	0.228571	2.957143	0.110421	0.218527	0.467469	0.08	0.424393342	2.970753	0.652965
0.142857	0.057143	2.614286	0.007806	0.874108	0.934937	0.12	0.254410703	1.780875	0.311554
0.214286	0.085714	2.671429	0.017189	0.582739	0.763373	0.12	0.311488759	2.180421	0.397203
0.285714	0.114286	2.728571	0.029918	0.437054	0.661101	0.12	0.35956141	2.51693	0.473847
0.357143	0.142857	2.785714	0.045788	0.349643	0.591306	0.12	0.401873495	2.813114	0.544731
0.428571	0.171429	2.842857	0.064609	0.291369	0.539786	0.12	0.440089722	3.080628	0.611518
0.5	0.2	2.9	0.086207	0.249745	0.499745	0.12	0.475199325	3.326395	0.675199
0.571429	0.228571	2.957143	0.110421	0.218527	0.467469	0.12	0.507847055	3.554929	0.736418
0.142857	0.057143	2.614286	0.007806	0.874108	0.934937	0.16	0.294740579	2.063184	0.351883
0.214286	0.085714	2.671429	0.017189	0.582739	0.763373	0.16	0.360877451	2.526142	0.446592
0.285714	0.114286	2.728571	0.029918	0.437054	0.661101	0.16	0.41658465	2.916093	0.53087
0.357143	0.142857	2.785714	0.045788	0.349643	0.591306	0.16	0.46562081	3.259346	0.608478
0.428571	0.171429	2.842857	0.064609	0.291369	0.539786	0.16	0.50991417	3.569399	0.681343
0.5	0.2	2.9	0.086207	0.249745	0.499745	0.16	0.550610533	3.854274	0.750611
0.571429	0.228571	2.957143	0.110421	0.218527	0.467469	0.16	0.588456672	4.119197	0.817028
0.142857	0.057143	2.614286	0.007806	0.874108	0.934937	0.2	0.335695638	2.349869	0.392838
0.214286	0.085714	2.671429	0.017189	0.582739	0.763373	0.2	0.411024867	2.877174	0.496739
0.285714	0.114286	2.728571	0.029918	0.437054	0.661101	0.2	0.474475947	3.321332	0.588762
0.357143	0.142857	2.785714	0.045788	0.349643	0.591306	0.2	0.53032965	3.712308	0.673187
0.428571	0.171429	2.842857	0.064609	0.291369	0.539786	0.2	0.580782065	4.065474	0.752211
0.5	0.2	2.9	0.086207	0.249745	0.499745	0.2	0.627138152	4.389967	0.827138
0.571429	0.228571	2.957143	0.110421	0.218527	0.467469	0.2	0.670248407	4.691739	0.89882
0.142857	0.057143	2.614286	0.007806	0.874108	0.934937	0.24	0.378483395	2.649384	0.435626
0.214286	0.085714	2.671429	0.017189	0.582739	0.763373	0.24	0.463411398	3.24388	0.549126
0.285714	0.114286	2.728571	0.029918	0.437054	0.661101	0.24	0.534946432	3.744625	0.649232
0.357143	0.142857	2.785714	0.045788	0.349643	0.591306	0.24	0.597915043	4.185405	0.740772
0.428571	0.171429	2.842857	0.064609	0.291369	0.539786	0.24	0.654793328	4.583553	0.826222
0.5	0.2	2.9	0.086207	0.249745	0.499745	0.24	0.707052636	4.949368	0.907053
0.571429	0.228571	2.957143	0.110421	0.218527	0.467469	0.24	0.755651917	5.289563	0.984223
0.142857	0.047619	3.095238	0.006593	1.04893	1.024173	0.08	0.193516727	1.354617	0.241136
0.214286	0.071429	3.142857	0.01461	0.699286	0.836233	0.08	0.236927766	1.658494	0.308356
0.285714	0.095238	3.190476	0.025586	0.524465	0.724199	0.08	0.273487259	1.914411	0.368725
0.357143	0.119048	3.238095	0.039391	0.419572	0.647744	0.08	0.305663671	2.139646	0.424711
0.428571	0.142857	3.285714	0.055901	0.349643	0.591306	0.08	0.334723433	2.343064	0.477581
0.5	0.166667	3.333333	0.075	0.299694	0.547443	0.08	0.361419125	2.529934	0.528086
0.571429	0.190476	3.380952	0.096579	0.262232	0.512086	0.08	0.386241265	2.703689	0.576717
0.142857	0.047619	3.095238	0.006593	1.04893	1.024173	0.12	0.23162028	1.621342	0.279239

PRILOG BROJ 1

Tip riblje staze:		normalna naizmjenična rebra
M	N	
0.077	18	

Q (m ³ /s)	v (m/s)	b (m)	pret. Δh	pretp. L
0.15	0.7	3	3	25
0.2	0.7	3	3	25
0.25	0.7	3	3	25
0.3	0.7	3	3	25
0.35	0.7	3	3	25
0.4	0.7	3	3	25
0.1	0.7	3	4	25
0.15	0.7	3	4	25
0.2	0.7	3	4	25
0.25	0.7	3	4	25
0.3	0.7	3	4	25
0.35	0.7	3	4	25
0.4	0.7	3	4	25
0.1	0.7	3	5	25
0.15	0.7	3	5	25
0.2	0.7	3	5	25
0.25	0.7	3	5	25
0.3	0.7	3	5	25
0.35	0.7	3	5	25
0.4	0.7	3	5	25
0.1	0.7	3	6	25
0.15	0.7	3	6	25
0.2	0.7	3	6	25
0.25	0.7	3	6	25
0.3	0.7	3	6	25
0.35	0.7	3	6	25
0.4	0.7	3	6	25
0.1	0.7	3.5	2	25
0.15	0.7	3.5	2	25
0.2	0.7	3.5	2	25
0.25	0.7	3.5	2	25
0.3	0.7	3.5	2	25
0.35	0.7	3.5	2	25
0.4	0.7	3.5	2	25
0.1	0.7	3.5	3	25
0.15	0.7	3.5	3	25
0.2	0.7	3.5	3	25
0.25	0.7	3.5	3	25
0.3	0.7	3.5	3	25

$\omega = \frac{Q}{v}$	$h = \frac{\omega}{b}$	$\chi = b + 2h$	$\frac{\omega^2}{\chi}$	$\Pi_k = \frac{v^2}{gh}$	$\sqrt{\Pi_k}$	$i = \frac{\Delta h}{L}$	$\Delta = \frac{8g \cdot \omega^2 - M + 2i^2}{Q^2 \cdot \chi - N \log i} \cdot h \cdot \chi \cdot \sqrt{\Pi_k}$	$\delta = 7\Delta$	uk.Dubina
0.214286	0.071429	3.142857	0.01461	0.699286	0.836233	0.12	0.2836001	1.985201	0.355029
0.285714	0.095238	3.190476	0.025586	0.524465	0.724199	0.12	0.327385835	2.291701	0.422624
0.357143	0.119048	3.238095	0.039391	0.419572	0.647744	0.12	0.365930828	2.561516	0.484978
0.428571	0.142857	3.285714	0.055901	0.349643	0.591306	0.12	0.400750152	2.805251	0.543607
0.5	0.166667	3.333333	0.075	0.299694	0.547443	0.12	0.43274408	3.029209	0.599411
0.571429	0.190476	3.380952	0.096579	0.262232	0.512086	0.12	0.462499345	3.237495	0.652976
0.142857	0.047619	3.095238	0.006593	1.04893	1.024173	0.16	0.268404151	1.878829	0.316023
0.214286	0.071429	3.142857	0.01461	0.699286	0.836233	0.16	0.328647065	2.300529	0.400076
0.285714	0.095238	3.190476	0.025586	0.524465	0.724199	0.16	0.379397096	2.65578	0.474635
0.357143	0.119048	3.238095	0.039391	0.419572	0.647744	0.16	0.424076159	2.968533	0.543124
0.428571	0.142857	3.285714	0.055901	0.349643	0.591306	0.16	0.464439667	3.251078	0.607297
0.5	0.166667	3.333333	0.075	0.299694	0.547443	0.16	0.501530673	3.510715	0.668197
0.571429	0.190476	3.380952	0.096579	0.262232	0.512086	0.16	0.53602895	3.752203	0.726505
0.142857	0.047619	3.095238	0.006593	1.04893	1.024173	0.2	0.305715036	2.140005	0.353334
0.214286	0.071429	3.142857	0.01461	0.699286	0.836233	0.2	0.374334188	2.620339	0.445763
0.285714	0.095238	3.190476	0.025586	0.524465	0.724199	0.2	0.432141428	3.02499	0.52738
0.357143	0.119048	3.238095	0.039391	0.419572	0.647744	0.2	0.48303425	3.38124	0.602082
0.428571	0.142857	3.285714	0.055901	0.349643	0.591306	0.2	0.529012021	3.703084	0.671869
0.5	0.166667	3.333333	0.075	0.299694	0.547443	0.2	0.571262746	3.998839	0.737929
0.571429	0.190476	3.380952	0.096579	0.262232	0.512086	0.2	0.610560662	4.273925	0.801037
0.142857	0.047619	3.095238	0.006593	1.04893	1.024173	0.24	0.344664605	2.412652	0.392284
0.214286	0.071429	3.142857	0.01461	0.699286	0.836233	0.24	0.422024119	2.954169	0.493453
0.285714	0.095238	3.190476	0.025586	0.524465	0.724199	0.24	0.487193596	3.410355	0.582432
0.357143	0.119048	3.238095	0.039391	0.419572	0.647744	0.24	0.544567204	3.81197	0.663615
0.428571	0.142857	3.285714	0.055901	0.349643	0.591306	0.24	0.596399109	4.174794	0.739256
0.5	0.166667	3.333333	0.075	0.299694	0.547443	0.24	0.64402872	4.508201	0.810695
0.571429	0.190476	3.380952	0.096579	0.262232	0.512086	0.24	0.688328953	4.818303	0.878805
0.142857	0.040816	3.581633	0.005698	1.223751	1.106233	0.08	0.178537392	1.249762	0.219354
0.214286	0.061224	3.622449	0.012676	0.815834	0.903235	0.08	0.218598593	1.53019	0.279823
0.285714	0.081633	3.663265	0.022284	0.611876	0.782225	0.08	0.252341826	1.766393	0.333974
0.357143	0.102041	3.704082	0.034435	0.489501	0.699643	0.08	0.282043907	1.974307	0.384085
0.428571	0.122449	3.744898	0.049046	0.407917	0.638684	0.08	0.308872882	2.16211	0.431322
0.5	0.142857	3.785714	0.066038	0.349643	0.591306	0.08	0.333522835	2.33466	0.47638
0.571429	0.163265	3.826531	0.085333	0.305938	0.553116	0.08	0.356446134	2.495123	0.519711
0.142857	0.040816	3.581633	0.005698	1.223751	1.106233	0.12	0.213854597	1.496982	0.254671
0.214286	0.061224	3.622449	0.012676	0.815834	0.903235	0.12	0.261857289	1.833001	0.323082
0.285714	0.081633	3.663265	0.022284	0.611876	0.782225	0.12	0.302297432	2.116082	0.38393
0.357143	0.102041	3.704082	0.034435	0.489501	0.699643	0.12	0.337901302	2.365309	0.439942
0.428571	0.122449	3.744898	0.049046	0.407917	0.638684	0.12	0.370067432	2.590472	0.492516

PRILOG BROJ 1

Tip riblje staze:		normalna naizmjenična rebra
M	N	
0.077	18	

Q (m ³ /s)	v (m/s)	b (m)	pret. Δh	pretp. L
0.35	0.7	3.5	3	25
0.4	0.7	3.5	3	25
0.1	0.7	3.5	4	25
0.15	0.7	3.5	4	25
0.2	0.7	3.5	4	25
0.25	0.7	3.5	4	25
0.3	0.7	3.5	4	25
0.35	0.7	3.5	4	25
0.4	0.7	3.5	4	25
0.1	0.7	3.5	5	25
0.15	0.7	3.5	5	25
0.2	0.7	3.5	5	25
0.25	0.7	3.5	5	25
0.3	0.7	3.5	5	25
0.35	0.7	3.5	5	25
0.4	0.7	3.5	5	25
0.1	0.7	3.5	6	25
0.15	0.7	3.5	6	25
0.2	0.7	3.5	6	25
0.25	0.7	3.5	6	25
0.3	0.7	3.5	6	25
0.35	0.7	3.5	6	25
0.4	0.7	3.5	6	25
0.1	0.7	4	2	25
0.15	0.7	4	2	25
0.2	0.7	4	2	25
0.25	0.7	4	2	25
0.3	0.7	4	2	25
0.35	0.7	4	2	25
0.4	0.7	4	2	25
0.1	0.7	4	3	25
0.15	0.7	4	3	25
0.2	0.7	4	3	25
0.25	0.7	4	3	25
0.3	0.7	4	3	25
0.35	0.7	4	3	25
0.4	0.7	4	3	25
0.1	0.7	4	4	25
0.15	0.7	4	4	25

$\omega = \frac{Q}{v}$	$h = \frac{\omega}{b}$	$\chi = b + 2h$	$\frac{\omega^2}{\chi}$	$\Pi_k = \frac{v^2}{gh}$	$\sqrt{\Pi_k}$	$i = \frac{\Delta h}{L}$	$\Delta = \frac{8g \cdot \omega^2 - M + 2i^2}{Q^2 \cdot \frac{\chi}{-N \log i} \cdot h \cdot \frac{\chi}{b} \cdot \sqrt{\Pi_k}}$	$\delta = 7\Delta$	uk.Dubina
0.5	0.142857	3.785714	0.066038	0.349643	0.591306	0.12	0.39962681	2.797388	0.542484
0.571429	0.163265	3.826531	0.085333	0.305938	0.553116	0.12	0.427120997	2.989847	0.590386
0.142857	0.040816	3.581633	0.005698	1.223751	1.106233	0.16	0.24787979	1.735159	0.288696
0.214286	0.061224	3.622449	0.012676	0.815834	0.903235	0.16	0.30352638	2.124685	0.364751
0.285714	0.081633	3.663265	0.022284	0.611876	0.782225	0.16	0.350409188	2.452864	0.432042
0.357143	0.102041	3.704082	0.034435	0.489501	0.699643	0.16	0.391687892	2.741815	0.493729
0.428571	0.122449	3.744898	0.049046	0.407917	0.638684	0.16	0.428983321	3.002883	0.551432
0.5	0.142857	3.785714	0.066038	0.349643	0.591306	0.16	0.463258524	3.24281	0.606116
0.571429	0.163265	3.826531	0.085333	0.305938	0.553116	0.16	0.495141117	3.465988	0.658406
0.142857	0.040816	3.581633	0.005698	1.223751	1.106233	0.2	0.282351987	1.976464	0.323168
0.214286	0.061224	3.622449	0.012676	0.815834	0.903235	0.2	0.345738733	2.420171	0.406963
0.285714	0.081633	3.663265	0.022284	0.611876	0.782225	0.2	0.399143392	2.794004	0.480776
0.357143	0.102041	3.704082	0.034435	0.489501	0.699643	0.2	0.446164973	3.123155	0.548206
0.428571	0.122449	3.744898	0.049046	0.407917	0.638684	0.2	0.488649657	3.420548	0.611099
0.5	0.142857	3.785714	0.066038	0.349643	0.591306	0.2	0.527694392	3.693861	0.670552
0.571429	0.163265	3.826531	0.085333	0.305938	0.553116	0.2	0.564014046	3.948098	0.727279
0.142857	0.040816	3.581633	0.005698	1.223751	1.106233	0.24	0.318309167	2.228164	0.359125
0.214286	0.061224	3.622449	0.012676	0.815834	0.903235	0.24	0.389766506	2.728366	0.450991
0.285714	0.081633	3.663265	0.022284	0.611876	0.782225	0.24	0.449970049	3.14979	0.531603
0.357143	0.102041	3.704082	0.034435	0.489501	0.699643	0.24	0.502977221	3.520841	0.605018
0.428571	0.122449	3.744898	0.049046	0.407917	0.638684	0.24	0.55086937	3.856086	0.673318
0.5	0.142857	3.785714	0.066038	0.349643	0.591306	0.24	0.594883174	4.164182	0.73774
0.571429	0.163265	3.826531	0.085333	0.305938	0.553116	0.24	0.635824569	4.450772	0.79909
0.142857	0.035714	4.071429	0.005013	1.398573	1.182613	0.08	0.16641839	1.164929	0.202133
0.214286	0.053571	4.107143	0.01118	0.932382	0.965599	0.08	0.203767554	1.426373	0.257339
0.285714	0.071429	4.142857	0.019704	0.699286	0.836233	0.08	0.235229865	1.646609	0.306658
0.357143	0.089286	4.178571	0.030525	0.559429	0.74795	0.08	0.262927188	1.84049	0.352213
0.428571	0.107143	4.214286	0.043584	0.466191	0.682782	0.08	0.287948036	2.015636	0.395091
0.5	0.125	4.25	0.058824	0.399592	0.632133	0.08	0.310939207	2.176574	0.435939
0.571429	0.142857	4.285714	0.07619	0.349643	0.591306	0.08	0.332322238	2.326256	0.475179
0.142857	0.035714	4.071429	0.005013	1.398573	1.182613	0.12	0.19949245	1.396447	0.235207
0.214286	0.053571	4.107143	0.01118	0.932382	0.965599	0.12	0.244278219	1.709948	0.29785
0.285714	0.071429	4.142857	0.019704	0.699286	0.836233	0.12	0.282011453	1.97408	0.35344
0.357143	0.089286	4.178571	0.030525	0.559429	0.74795	0.12	0.315234956	2.206645	0.404521
0.428571	0.107143	4.214286	0.043584	0.466191	0.682782	0.12	0.345253103	2.416772	0.452396
0.5	0.125	4.25	0.058824	0.399592	0.632133	0.12	0.372840917	2.609886	0.497841
0.571429	0.142857	4.285714	0.07619	0.349643	0.591306	0.12	0.398503467	2.789524	0.541361
0.142857	0.035714	4.071429	0.005013	1.398573	1.182613	0.16	0.231291793	1.619043	0.267006
0.214286	0.053571	4.107143	0.01118	0.932382	0.965599	0.16	0.283221773	1.982552	0.336793

PRILOG BROJ 1

Tip riblje staze:		normalna naizmjenična rebra
M	N	
0.077	18	

Q (m ³ /s)	v (m/s)	b (m)	pret. Δh	pretp. L
0.2	0.7	4	4	25
0.25	0.7	4	4	25
0.3	0.7	4	4	25
0.35	0.7	4	4	25
0.4	0.7	4	4	25
0.1	0.7	4	5	25
0.15	0.7	4	5	25
0.2	0.7	4	5	25
0.25	0.7	4	5	25
0.3	0.7	4	5	25
0.35	0.7	4	5	25
0.4	0.7	4	5	25
0.1	0.7	4	6	25
0.15	0.7	4	6	25
0.2	0.7	4	6	25
0.25	0.7	4	6	25
0.3	0.7	4	6	25
0.35	0.7	4	6	25
0.4	0.7	4	6	25

$\omega = \frac{Q}{v}$	$h = \frac{\omega}{b}$	$\chi = b + 2h$	$\frac{\omega^2}{\chi}$	$\Pi_k = \frac{v^2}{gh}$	$\sqrt{\Pi_k}$	$i = \frac{\Delta h}{L}$	$\Delta = \frac{8g \cdot \frac{\omega^2}{\chi} - M + 2i^2}{-N \log i} \cdot h \cdot \frac{\chi}{b} \cdot \sqrt{\Pi_k}$	$\delta = 7\Delta$	uk. Dubina
0.285714	0.071429	4.142857	0.019704	0.699286	0.836233	0.16	0.326976677	2.288837	0.398405
0.357143	0.089286	4.178571	0.030525	0.559429	0.74795	0.16	0.36550434	2.55853	0.45479
0.428571	0.107143	4.214286	0.043584	0.466191	0.682782	0.16	0.400316879	2.802218	0.50746
0.5	0.125	4.25	0.058824	0.399592	0.632133	0.16	0.43231273	3.026189	0.557313
0.571429	0.142857	4.285714	0.07619	0.349643	0.591306	0.16	0.462077382	3.234542	0.604935
0.142857	0.035714	4.071429	0.005013	1.398573	1.182613	0.2	0.26347073	1.844295	0.299185
0.214286	0.053571	4.107143	0.01118	0.932382	0.965599	0.2	0.322626792	2.258388	0.376198
0.285714	0.071429	4.142857	0.019704	0.699286	0.836233	0.2	0.37247078	2.607295	0.443899
0.357143	0.089286	4.178571	0.030525	0.559429	0.74795	0.2	0.416360586	2.914524	0.505646
0.428571	0.107143	4.214286	0.043584	0.466191	0.682782	0.2	0.456018663	3.192131	0.563162
0.5	0.125	4.25	0.058824	0.399592	0.632133	0.2	0.492468413	3.447279	0.617468
0.571429	0.142857	4.285714	0.07619	0.349643	0.591306	0.2	0.526376763	3.684637	0.669234
0.142857	0.035714	4.071429	0.005013	1.398573	1.182613	0.24	0.297008463	2.079059	0.332723
0.214286	0.053571	4.107143	0.01118	0.932382	0.965599	0.24	0.363693283	2.545853	0.417265
0.285714	0.071429	4.142857	0.019704	0.699286	0.836233	0.24	0.419880264	2.939162	0.491309
0.357143	0.089286	4.178571	0.030525	0.559429	0.74795	0.24	0.469354802	3.285484	0.558641
0.428571	0.107143	4.214286	0.043584	0.466191	0.682782	0.24	0.514058651	3.598411	0.621202
0.5	0.125	4.25	0.058824	0.399592	0.632133	0.24	0.555145516	3.886019	0.680146
0.571429	0.142857	4.285714	0.07619	0.349643	0.591306	0.24	0.593367239	4.153571	0.736224

Tip riblje staze:		normalna naizmjenična rebra
M	N	
0.077	18	

ULAZNI PARAMETRI				
M=0.077	N=18			
Q (m ³ /s)	v (m/s)	b (m)	pret. Δh	pretp. L
0.1	1	2	2	25
0.15	1	2	2	25
0.2	1	2	2	25
0.25	1	2	2	25
0.3	1	2	2	25
0.35	1	2	2	25
0.4	1	2	2	25
0.1	1	2	3	25
0.15	1	2	3	25
0.2	1	2	3	25
0.25	1	2	3	25
0.3	1	2	3	25
0.35	1	2	3	25
0.4	1	2	3	25
0.1	1	2	4	25
0.15	1	2	4	25
0.2	1	2	4	25
0.25	1	2	4	25
0.3	1	2	4	25
0.35	1	2	4	25
0.4	1	2	4	25
0.1	1	2	5	25
0.15	1	2	5	25
0.2	1	2	5	25
0.25	1	2	5	25
0.3	1	2	5	25
0.35	1	2	5	25
0.4	1	2	5	25
0.1	1	2	6	25
0.15	1	2	6	25
0.2	1	2	6	25
0.25	1	2	6	25
0.3	1	2	6	25
0.35	1	2	6	25
0.4	1	2	6	25
0.1	1	2.5	2	25
0.15	1	2.5	2	25

IZRAČUNATE VRIJEDNOSTI									
$\omega = \frac{Q}{v}$	$h = \frac{\omega}{b}$	$\chi = b + 2h$	$\frac{\omega^2}{\chi}$	$\Pi_k = \frac{v^2}{gh}$	$\sqrt{\Pi_k}$	$i = \frac{\Delta h}{L}$	$\Delta = \frac{8g}{Q^2} \cdot \frac{\omega^2}{\chi} \cdot \frac{M + 2i^2}{i} \cdot h \cdot \frac{\chi}{b} \cdot \sqrt{\Pi_k}$	$\delta = 7\Delta$	uk.Dubina
0.1	0.05	2.1	0.004762	2.038736	1.427843	0.08	0.137623141	0.963362	0.187623
0.15	0.075	2.15	0.010465	1.359157	1.165829	0.08	0.168428963	1.179003	0.243429
0.2	0.1	2.2	0.018182	1.019368	1.009638	0.08	0.194341515	1.360391	0.294342
0.25	0.125	2.25	0.027778	0.815494	0.903047	0.08	0.217119983	1.51984	0.34212
0.3	0.15	2.3	0.03913	0.679579	0.824366	0.08	0.237667275	1.663671	0.387667
0.35	0.175	2.35	0.052128	0.582496	0.763214	0.08	0.256520166	1.795641	0.43152
0.4	0.2	2.4	0.066667	0.509684	0.713922	0.08	0.274028654	1.918201	0.474029
0.1	0.05	2.1	0.004762	2.038736	1.427843	0.12	0.165030481	1.155213	0.21503
0.15	0.075	2.15	0.010465	1.359157	1.165829	0.12	0.202003959	1.414028	0.277004
0.2	0.1	2.2	0.018182	1.019368	1.009638	0.12	0.233119815	1.631839	0.33312
0.25	0.125	2.25	0.027778	0.815494	0.903047	0.12	0.260485763	1.8234	0.385486
0.3	0.15	2.3	0.03913	0.679579	0.824366	0.12	0.285183416	1.996284	0.435183
0.35	0.175	2.35	0.052128	0.582496	0.763214	0.12	0.307855679	2.15499	0.482856
0.4	0.2	2.4	0.066667	0.509684	0.713922	0.12	0.328921685	2.302452	0.528922
0.1	0.05	2.1	0.004762	2.038736	1.427843	0.16	0.191358066	1.339506	0.241358
0.15	0.075	2.15	0.010465	1.359157	1.165829	0.16	0.23424255	1.639698	0.309243
0.2	0.1	2.2	0.018182	1.019368	1.009638	0.16	0.270338825	1.892372	0.370339
0.25	0.125	2.25	0.027778	0.815494	0.903047	0.16	0.302090158	2.114631	0.42709
0.3	0.15	2.3	0.03913	0.679579	0.824366	0.16	0.330750286	2.315252	0.48075
0.35	0.175	2.35	0.052128	0.582496	0.763214	0.16	0.357064385	2.499451	0.532064
0.4	0.2	2.4	0.066667	0.509684	0.713922	0.16	0.381518234	2.670628	0.581518
0.1	0.05	2.1	0.004762	2.038736	1.427843	0.2	0.217986085	1.525903	0.267986
0.15	0.075	2.15	0.010465	1.359157	1.165829	0.2	0.266840952	1.867887	0.341841
0.2	0.1	2.2	0.018182	1.019368	1.009638	0.2	0.307963904	2.155747	0.407964
0.25	0.125	2.25	0.027778	0.815494	0.903047	0.2	0.344138036	2.408966	0.469138
0.3	0.15	2.3	0.03913	0.679579	0.824366	0.2	0.37679145	2.63754	0.526791
0.35	0.175	2.35	0.052128	0.582496	0.763214	0.2	0.406772945	2.847411	0.581773
0.4	0.2	2.4	0.066667	0.509684	0.713922	0.2	0.43463585	3.042451	0.634636
0.1	0.05	2.1	0.004762	2.038736	1.427843	0.24	0.245728555	1.7201	0.295729
0.15	0.075	2.15	0.010465	1.359157	1.165829	0.24	0.300797873	2.105585	0.375798
0.2	0.1	2.2	0.018182	1.019368	1.009638	0.24	0.347150277	2.430052	0.44715
0.25	0.125	2.25	0.027778	0.815494	0.903047	0.24	0.387923234	2.715463	0.512923
0.3	0.15	2.3	0.03913	0.679579	0.824366	0.24	0.424726702	2.973087	0.574727
0.35	0.175	2.35	0.052128	0.582496	0.763214	0.24	0.45851758	3.209623	0.633518
0.4	0.2	2.4	0.066667	0.509684	0.713922	0.24	0.489919672	3.429438	0.68992
0.1	0.04	2.58	0.003876	2.54842	1.596377	0.08	0.122222616	0.855558	0.162223
0.15	0.06	2.62	0.008588	1.698947	1.303436	0.08	0.149602599	1.047218	0.209603

Tip riblje staze:		normalna naizmjenična rebra
M	N	
0.077	18	

ULAZNI PARAMETRI				
M=0.077	N=18			
Q (m ³ /s)	v (m/s)	b (m)	pret. Δh	pretp. L
0.2	1	2.5	2	25
0.25	1	2.5	2	25
0.3	1	2.5	2	25
0.35	1	2.5	2	25
0.4	1	2.5	2	25
0.1	1	2.5	3	25
0.15	1	2.5	3	25
0.2	1	2.5	3	25
0.25	1	2.5	3	25
0.3	1	2.5	3	25
0.35	1	2.5	3	25
0.4	1	2.5	3	25
0.1	1	2.5	4	25
0.15	1	2.5	4	25
0.2	1	2.5	4	25
0.25	1	2.5	4	25
0.3	1	2.5	4	25
0.35	1	2.5	4	25
0.4	1	2.5	4	25
0.1	1	2.5	5	25
0.15	1	2.5	5	25
0.2	1	2.5	5	25
0.25	1	2.5	5	25
0.3	1	2.5	5	25
0.35	1	2.5	5	25
0.4	1	2.5	5	25
0.1	1	2.5	6	25
0.15	1	2.5	6	25
0.2	1	2.5	6	25
0.25	1	2.5	6	25
0.3	1	2.5	6	25
0.35	1	2.5	6	25
0.4	1	2.5	6	25
0.1	1	3	2	25
0.15	1	3	2	25
0.2	1	3	2	25
0.25	1	3	2	25

IZRAČUNATE VRIJEDNOSTI									
$\omega = \frac{Q}{v}$	$h = \frac{\omega}{b}$	$\chi = b + 2h$	$\frac{\omega^2}{\chi}$	$\Pi_k = \frac{v^2}{gh}$	$\sqrt{\Pi_k}$	$i = \frac{\Delta h}{L}$	$\Delta = \frac{8g \cdot \omega^2 - M + 2i^2}{Q^2 \cdot \chi - N \log i} \cdot h \cdot \frac{\chi}{b} \sqrt{\Pi_k}$	$\delta = 7\Delta$	uk.Dubina
0.2	0.08	2.66	0.015038	1.27421	1.128809	0.08	0.172643522	1.208505	0.252644
0.25	0.1	2.7	0.023148	1.019368	1.009638	0.08	0.192906527	1.350346	0.292907
0.3	0.12	2.74	0.032847	0.849473	0.921669	0.08	0.211192756	1.478349	0.331193
0.35	0.14	2.78	0.044065	0.72812	0.853299	0.08	0.227978416	1.595849	0.367978
0.4	0.16	2.82	0.056738	0.637105	0.798189	0.08	0.243573968	1.705018	0.403574
0.1	0.04	2.58	0.003876	2.54842	1.596377	0.12	0.146792549	1.027548	0.186793
0.15	0.06	2.62	0.008588	1.698947	1.303436	0.12	0.179700221	1.257902	0.2397
0.2	0.08	2.66	0.015038	1.27421	1.128809	0.12	0.207403869	1.451827	0.287404
0.25	0.1	2.7	0.023148	1.019368	1.009638	0.12	0.231777163	1.62244	0.331777
0.3	0.12	2.74	0.032847	0.849473	0.921669	0.12	0.253781497	1.77647	0.373781
0.35	0.14	2.78	0.044065	0.72812	0.853299	0.12	0.273988254	1.917918	0.413988
0.4	0.16	2.82	0.056738	0.637105	0.798189	0.12	0.292769898	2.049389	0.45277
0.1	0.04	2.58	0.003876	2.54842	1.596377	0.16	0.170298712	1.192091	0.210299
0.15	0.06	2.62	0.008588	1.698947	1.303436	0.16	0.208484992	1.459395	0.268485
0.2	0.08	2.66	0.015038	1.27421	1.128809	0.16	0.240636716	1.684457	0.320637
0.25	0.1	2.7	0.023148	1.019368	1.009638	0.16	0.268927089	1.88249	0.368927
0.3	0.12	2.74	0.032847	0.849473	0.921669	0.16	0.294471148	2.061298	0.414471
0.35	0.14	2.78	0.044065	0.72812	0.853299	0.16	0.317931561	2.225521	0.457932
0.4	0.16	2.82	0.056738	0.637105	0.798189	0.16	0.339740277	2.378182	0.49974
0.1	0.04	2.58	0.003876	2.54842	1.596377	0.2	0.194016489	1.358115	0.234016
0.15	0.06	2.62	0.008588	1.698947	1.303436	0.2	0.237523109	1.662662	0.297523
0.2	0.08	2.66	0.015038	1.27421	1.128809	0.2	0.274155373	1.919088	0.354155
0.25	0.1	2.7	0.023148	1.019368	1.009638	0.2	0.306389036	2.144723	0.406389
0.3	0.12	2.74	0.032847	0.849473	0.921669	0.2	0.335494358	2.348461	0.455494
0.35	0.14	2.78	0.044065	0.72812	0.853299	0.2	0.362226251	2.535584	0.502226
0.4	0.16	2.82	0.056738	0.637105	0.798189	0.2	0.387076785	2.709537	0.547077
0.1	0.04	2.58	0.003876	2.54842	1.596377	0.24	0.2186862	1.530803	0.258686
0.15	0.06	2.62	0.008588	1.698947	1.303436	0.24	0.267722523	1.874058	0.327723
0.2	0.08	2.66	0.015038	1.27421	1.128809	0.24	0.309009693	2.163068	0.38901
0.25	0.1	2.7	0.023148	1.019368	1.009638	0.24	0.345338389	2.417369	0.445338
0.3	0.12	2.74	0.032847	0.849473	0.921669	0.24	0.378140465	2.646983	0.49814
0.35	0.14	2.78	0.044065	0.72812	0.853299	0.24	0.408266876	2.857868	0.548267
0.4	0.16	2.82	0.056738	0.637105	0.798189	0.24	0.436272299	3.053906	0.596272
0.1	0.033333	3.066667	0.003261	3.058104	1.748744	0.08	0.110767075	0.77537	0.1441
0.15	0.05	3.1	0.007258	2.038736	1.427843	0.08	0.135593761	0.949156	0.185594
0.2	0.066667	3.133333	0.012766	1.529052	1.236548	0.08	0.156492078	1.095445	0.223159
0.25	0.083333	3.166667	0.019737	1.223242	1.106003	0.08	0.174876132	1.224133	0.258209

Tip riblje staze:		normalna naizmjenična rebra
M	N	
0.077	18	

ULAZNI PARAMETRI				
M=0.077	N=18			
Q (m ³ /s)	v (m/s)	b (m)	pret. Δh	pretp. L
0.3	1	3	2	25
0.35	1	3	2	25
0.4	1	3	2	25
0.1	1	3	3	25
0.15	1	3	3	25
0.2	1	3	3	25
0.25	1	3	3	25
0.3	1	3	3	25
0.35	1	3	3	25
0.4	1	3	3	25
0.1	1	3	4	25
0.15	1	3	4	25
0.2	1	3	4	25
0.25	1	3	4	25
0.3	1	3	4	25
0.35	1	3	4	25
0.4	1	3	4	25
0.1	1	3	5	25
0.15	1	3	5	25
0.2	1	3	5	25
0.25	1	3	5	25
0.3	1	3	5	25
0.35	1	3	5	25
0.4	1	3	5	25
0.1	1	3	6	25
0.15	1	3	6	25
0.2	1	3	6	25
0.25	1	3	6	25
0.3	1	3	6	25
0.35	1	3	6	25
0.4	1	3	6	25
0.1	1	3.5	2	25
0.15	1	3.5	2	25
0.2	1	3.5	2	25
0.25	1	3.5	2	25
0.3	1	3.5	2	25
0.35	1	3.5	2	25

IZRAČUNATE VRIJEDNOSTI									
$\omega = \frac{Q}{v}$	$h = \frac{\omega}{b}$	$\chi = b + 2h$	$\frac{\omega^2}{\chi}$	$\Pi_k = \frac{v^2}{gh}$	$\sqrt{\Pi_k}$	$i = \frac{\Delta h}{L}$	$\Delta = \frac{8g \cdot \omega^2 - M + 2i^2}{Q^2 \cdot \chi - N \log i} \cdot h \cdot \frac{\chi}{b} \sqrt{\Pi_k}$	$\delta = 7\Delta$	uk.Dubina
0.3	0.1	3.2	0.028125	1.019368	1.009638	0.08	0.191471538	1.340301	0.291472
0.35	0.116667	3.233333	0.037887	0.873744	0.934743	0.08	0.206709568	1.446967	0.323376
0.4	0.133333	3.266667	0.04898	0.764526	0.874372	0.08	0.220871358	1.5461	0.354205
0.1	0.033333	3.066667	0.003261	3.058104	1.748744	0.12	0.133248142	0.932737	0.166581
0.15	0.05	3.1	0.007258	2.038736	1.427843	0.12	0.163131685	1.141922	0.213132
0.2	0.066667	3.133333	0.012766	1.529052	1.236548	0.12	0.18829516	1.318066	0.254962
0.25	0.083333	3.166667	0.019737	1.223242	1.106003	0.12	0.210438678	1.473071	0.293772
0.3	0.1	3.2	0.028125	1.019368	1.009638	0.12	0.230434512	1.613042	0.330435
0.35	0.116667	3.233333	0.037887	0.873744	0.934743	0.12	0.248801038	1.741607	0.365468
0.4	0.133333	3.266667	0.04898	0.764526	0.874372	0.12	0.26587614	1.861133	0.399209
0.1	0.033333	3.066667	0.003261	3.058104	1.748744	0.16	0.154667412	1.082672	0.188001
0.15	0.05	3.1	0.007258	2.038736	1.427843	0.16	0.18936157	1.325531	0.239362
0.2	0.066667	3.133333	0.012766	1.529052	1.236548	0.16	0.218579062	1.530053	0.285246
0.25	0.083333	3.166667	0.019737	1.223242	1.106003	0.16	0.244292904	1.71005	0.327626
0.3	0.1	3.2	0.028125	1.019368	1.009638	0.16	0.267515353	1.872607	0.367515
0.35	0.116667	3.233333	0.037887	0.873744	0.934743	0.16	0.288847949	2.021936	0.405515
0.4	0.133333	3.266667	0.04898	0.764526	0.874372	0.16	0.308682771	2.160779	0.442016
0.1	0.033333	3.066667	0.003261	3.058104	1.748744	0.2	0.176227009	1.233589	0.20956
0.15	0.05	3.1	0.007258	2.038736	1.427843	0.2	0.215758885	1.510312	0.265759
0.2	0.066667	3.133333	0.012766	1.529052	1.236548	0.2	0.249051176	1.743358	0.315718
0.25	0.083333	3.166667	0.019737	1.223242	1.106003	0.2	0.278351836	1.948463	0.361685
0.3	0.1	3.2	0.028125	1.019368	1.009638	0.2	0.304814168	2.133699	0.404814
0.35	0.116667	3.233333	0.037887	0.873744	0.934743	0.2	0.329123527	2.303865	0.44579
0.4	0.133333	3.266667	0.04898	0.764526	0.874372	0.2	0.351726617	2.462086	0.48506
0.1	0.033333	3.066667	0.003261	3.058104	1.748744	0.24	0.198614076	1.390299	0.231947
0.15	0.05	3.1	0.007258	2.038736	1.427843	0.24	0.243166158	1.702163	0.293166
0.2	0.066667	3.133333	0.012766	1.529052	1.236548	0.24	0.280685467	1.964798	0.347352
0.25	0.083333	3.166667	0.019737	1.223242	1.106003	0.24	0.313705624	2.195939	0.397039
0.3	0.1	3.2	0.028125	1.019368	1.009638	0.24	0.343526501	2.404686	0.443527
0.35	0.116667	3.233333	0.037887	0.873744	0.934743	0.24	0.370920558	2.596444	0.487587
0.4	0.133333	3.266667	0.04898	0.764526	0.874372	0.24	0.396391277	2.774739	0.529725
0.1	0.028571	3.557143	0.002811	3.567788	1.888859	0.08	0.101797961	0.712586	0.130369
0.15	0.042857	3.585714	0.006275	2.378525	1.542247	0.08	0.12462285	0.87236	0.16748
0.2	0.057143	3.614286	0.011067	1.783894	1.335625	0.08	0.143840086	1.006881	0.200983
0.25	0.071429	3.642857	0.017157	1.427115	1.194619	0.08	0.160748803	1.125242	0.232177
0.3	0.085714	3.671429	0.024514	1.189263	1.090533	0.08	0.176015575	1.232109	0.26173
0.35	0.1	3.7	0.033108	1.019368	1.009638	0.08	0.19003655	1.330256	0.290037

Tip riblje staze:		normalna naizmjenična rebra
M	N	
0.077	18	

ULAZNI PARAMETRI				
M=0.077	N=18			
Q (m ³ /s)	v (m/s)	b (m)	pret. Δh	pretp. L
0.4	1	3.5	2	25
0.1	1	3.5	3	25
0.15	1	3.5	3	25
0.2	1	3.5	3	25
0.25	1	3.5	3	25
0.3	1	3.5	3	25
0.35	1	3.5	3	25
0.4	1	3.5	3	25
0.1	1	3.5	4	25
0.15	1	3.5	4	25
0.2	1	3.5	4	25
0.25	1	3.5	4	25
0.3	1	3.5	4	25
0.35	1	3.5	4	25
0.4	1	3.5	4	25
0.1	1	3.5	5	25
0.15	1	3.5	5	25
0.2	1	3.5	5	25
0.25	1	3.5	5	25
0.3	1	3.5	5	25
0.35	1	3.5	5	25
0.4	1	3.5	5	25
0.1	1	3.5	6	25
0.15	1	3.5	6	25
0.2	1	3.5	6	25
0.25	1	3.5	6	25
0.3	1	3.5	6	25
0.35	1	3.5	6	25
0.4	1	3.5	6	25
0.1	1	4	2	25
0.15	1	4	2	25
0.2	1	4	2	25
0.25	1	4	2	25
0.3	1	4	2	25
0.35	1	4	2	25
0.4	1	4	2	25
0.1	1	4	3	25

IZRAČUNATE VRIJEDNOSTI									
$\omega = \frac{Q}{v}$	$h = \frac{\omega}{b}$	$\chi = b + 2h$	$\frac{\omega^2}{\chi}$	$\Pi_k = \frac{v^2}{gh}$	$\sqrt{\Pi_k}$	$i = \frac{\Delta h}{L}$	$\Delta = \frac{8g \cdot \omega^2 - M + 2i^2}{Q^2 \cdot \chi - N \log i} \cdot h \cdot \frac{\chi}{b} \sqrt{\Pi_k}$	$\delta = 7\Delta$	uk.Dubina
0.4	0.114286	3.728571	0.042912	0.891947	0.944429	0.08	0.203069957	1.42149	0.317356
0.1	0.028571	3.557143	0.002811	3.567788	1.888859	0.12	0.122659801	0.858619	0.151231
0.15	0.042857	3.585714	0.006275	2.378525	1.542247	0.12	0.150176735	1.051237	0.193034
0.2	0.057143	3.614286	0.011067	1.783894	1.335625	0.12	0.17335116	1.213458	0.230494
0.25	0.071429	3.642857	0.017157	1.427115	1.194619	0.12	0.193747646	1.356234	0.265176
0.3	0.085714	3.671429	0.024514	1.189263	1.090533	0.12	0.212168881	1.485182	0.297883
0.35	0.1	3.7	0.033108	1.019368	1.009638	0.12	0.22909186	1.603643	0.329092
0.4	0.114286	3.728571	0.042912	0.891947	0.944429	0.12	0.24482748	1.713792	0.359113
0.1	0.028571	3.557143	0.002811	3.567788	1.888859	0.16	0.142453968	0.997178	0.171025
0.15	0.042857	3.585714	0.006275	2.378525	1.542247	0.16	0.174416955	1.220919	0.217274
0.2	0.057143	3.614286	0.011067	1.783894	1.335625	0.16	0.201338371	1.409369	0.258481
0.25	0.071429	3.642857	0.017157	1.427115	1.194619	0.16	0.225034963	1.575245	0.296464
0.3	0.085714	3.671429	0.024514	1.189263	1.090533	0.16	0.246438764	1.725071	0.332153
0.35	0.1	3.7	0.033108	1.019368	1.009638	0.16	0.266103617	1.862725	0.366104
0.4	0.114286	3.728571	0.042912	0.891947	0.944429	0.16	0.284390492	1.990733	0.398676
0.1	0.028571	3.557143	0.002811	3.567788	1.888859	0.2	0.162328739	1.136301	0.1909
0.15	0.042857	3.585714	0.006275	2.378525	1.542247	0.2	0.198752377	1.391267	0.24161
0.2	0.057143	3.614286	0.011067	1.783894	1.335625	0.2	0.229431448	1.60602	0.286574
0.25	0.071429	3.642857	0.017157	1.427115	1.194619	0.2	0.2564361	1.795053	0.327865
0.3	0.085714	3.671429	0.024514	1.189263	1.090533	0.2	0.280828356	1.965798	0.366543
0.35	0.1	3.7	0.033108	1.019368	1.009638	0.2	0.3032393	2.122675	0.403239
0.4	0.114286	3.728571	0.042912	0.891947	0.944429	0.2	0.324080242	2.268562	0.438366
0.1	0.028571	3.557143	0.002811	3.567788	1.888859	0.24	0.182930856	1.280516	0.211502
0.15	0.042857	3.585714	0.006275	2.378525	1.542247	0.24	0.223975847	1.567831	0.266833
0.2	0.057143	3.614286	0.011067	1.783894	1.335625	0.24	0.258546765	1.809827	0.31569
0.25	0.071429	3.642857	0.017157	1.427115	1.194619	0.24	0.288976567	2.022836	0.360405
0.3	0.085714	3.671429	0.024514	1.189263	1.090533	0.24	0.316462113	2.215235	0.402176
0.35	0.1	3.7	0.033108	1.019368	1.009638	0.24	0.341714612	2.392002	0.441715
0.4	0.114286	3.728571	0.042912	0.891947	0.944429	0.24	0.365197601	2.556383	0.479483
0.1	0.025	4.05	0.002469	4.077472	2.019275	0.08	0.094516029	0.661612	0.119516
0.15	0.0375	4.075	0.005521	2.718315	1.648731	0.08	0.115714085	0.809999	0.153214
0.2	0.05	4.1	0.009756	2.038736	1.427843	0.08	0.133564381	0.934951	0.183564
0.25	0.0625	4.125	0.015152	1.630989	1.277102	0.08	0.149272795	1.04491	0.211773
0.3	0.075	4.15	0.021687	1.359157	1.165829	0.08	0.163458017	1.144206	0.238458
0.35	0.0875	4.175	0.029341	1.164992	1.079348	0.08	0.176487722	1.235414	0.263988
0.4	0.1	4.2	0.038095	1.019368	1.009638	0.08	0.188601562	1.320211	0.288602
0.1	0.025	4.05	0.002469	4.077472	2.019275	0.12	0.114076002	0.798532	0.139076

Tip riblje staze:		normalna naizmjenična rebra
M	N	
0.077	18	

ULAZNI PARAMETRI					
M=0.077	N=18				
Q (m ³ /s)	v (m/s)	b (m)	pret. Δh	pretp. L	
0.15	1	4	3	25	
0.2	1	4	3	25	
0.25	1	4	3	25	
0.3	1	4	3	25	
0.35	1	4	3	25	
0.4	1	4	3	25	
0.1	1	4	4	25	
0.15	1	4	4	25	
0.2	1	4	4	25	
0.25	1	4	4	25	
0.3	1	4	4	25	
0.35	1	4	4	25	
0.4	1	4	4	25	
0.1	1	4	5	25	
0.15	1	4	5	25	
0.2	1	4	5	25	
0.25	1	4	5	25	
0.3	1	4	5	25	
0.35	1	4	5	25	
0.4	1	4	5	25	
0.1	1	4	6	25	
0.15	1	4	6	25	
0.2	1	4	6	25	
0.25	1	4	6	25	
0.3	1	4	6	25	
0.35	1	4	6	25	
0.4	1	4	6	25	

IZRAČUNATE VRIJEDNOSTI									
$\omega = \frac{Q}{v}$	$h = \frac{\omega}{b}$	$\chi = b + 2h$	$\frac{\omega^2}{\chi}$	$\Pi_k = \frac{v^2}{gh}$	$\sqrt{\Pi_k}$	$i = \frac{\Delta h}{L}$	$\Delta = \frac{8g}{Q^2} \cdot \frac{\omega^2 - M + 2i^2}{\chi} \cdot h \cdot \frac{\chi}{b} \sqrt{\Pi_k}$	$\delta = 7\Delta$	uk.Dubina
0.15	0.0375	4.075	0.005521	2.718315	1.648731	0.12	0.139672889	0.97771	0.177173
0.2	0.05	4.1	0.009756	2.038736	1.427843	0.12	0.16123289	1.12863	0.211233
0.25	0.0625	4.125	0.015152	1.630989	1.277102	0.12	0.180210778	1.261475	0.242711
0.3	0.075	4.15	0.021687	1.359157	1.165829	0.12	0.197352878	1.38147	0.272353
0.35	0.0875	4.175	0.029341	1.164992	1.079348	0.12	0.213102674	1.491719	0.300603
0.4	0.1	4.2	0.038095	1.019368	1.009638	0.12	0.227749209	1.594244	0.327749
0.1	0.025	4.05	0.002469	4.077472	2.019275	0.16	0.132557701	0.927904	0.157558
0.15	0.0375	4.075	0.005521	2.718315	1.648731	0.16	0.162306139	1.136143	0.199806
0.2	0.05	4.1	0.009756	2.038736	1.427843	0.16	0.187365074	1.311556	0.237365
0.25	0.0625	4.125	0.015152	1.630989	1.277102	0.16	0.209424717	1.465973	0.271925
0.3	0.075	4.15	0.021687	1.359157	1.165829	0.16	0.229352153	1.605465	0.304352
0.35	0.0875	4.175	0.029341	1.164992	1.079348	0.16	0.247662611	1.733638	0.335163
0.4	0.1	4.2	0.038095	1.019368	1.009638	0.16	0.264691881	1.852843	0.364692
0.1	0.025	4.05	0.002469	4.077472	2.019275	0.2	0.151068446	1.057479	0.176068
0.15	0.0375	4.075	0.005521	2.718315	1.648731	0.2	0.184972085	1.294805	0.222472
0.2	0.05	4.1	0.009756	2.038736	1.427843	0.2	0.213531686	1.494722	0.263532
0.25	0.0625	4.125	0.015152	1.630989	1.277102	0.2	0.23867343	1.670714	0.301173
0.3	0.075	4.15	0.021687	1.359157	1.165829	0.2	0.261385449	1.829698	0.336385
0.35	0.0875	4.175	0.029341	1.164992	1.079348	0.2	0.282254896	1.975784	0.369755
0.4	0.1	4.2	0.038095	1.019368	1.009638	0.2	0.301664432	2.111651	0.401664
0.1	0.025	4.05	0.002469	4.077472	2.019275	0.24	0.170223145	1.191562	0.195223
0.15	0.0375	4.075	0.005521	2.718315	1.648731	0.24	0.208424447	1.458971	0.245924
0.2	0.05	4.1	0.009756	2.038736	1.427843	0.24	0.240603761	1.684226	0.290604
0.25	0.0625	4.125	0.015152	1.630989	1.277102	0.24	0.268931561	1.882521	0.331432
0.3	0.075	4.15	0.021687	1.359157	1.165829	0.24	0.294521308	2.061649	0.369521
0.35	0.0875	4.175	0.029341	1.164992	1.079348	0.24	0.318034628	2.226242	0.405535
0.4	0.1	4.2	0.038095	1.019368	1.009638	0.24	0.339902724	2.379319	0.439903

PRILOG BROJ 1

Tip riblje staze:		normalna naizmjenična rebra
M	N	
0.077	18	

Q (m ³ /s)	v (m/s)	b (m)	pret. Δh	pretp. L
0.1	0.3	2	2	25
0.15	0.3	2	2	25
0.2	0.3	2	2	25
0.25	0.3	2	2	25
0.3	0.3	2	2	25
0.35	0.3	2	2	25
0.4	0.3	2	2	25
0.1	0.3	2	3	25
0.15	0.3	2	3	25
0.2	0.3	2	3	25
0.25	0.3	2	3	25
0.3	0.3	2	3	25
0.35	0.3	2	3	25
0.4	0.3	2	3	25
0.1	0.3	2	4	25
0.15	0.3	2	4	25
0.2	0.3	2	4	25
0.25	0.3	2	4	25
0.3	0.3	2	4	25
0.35	0.3	2	4	25
0.4	0.3	2	4	25
0.1	0.3	2	5	25
0.15	0.3	2	5	25
0.2	0.3	2	5	25
0.25	0.3	2	5	25
0.3	0.3	2	5	25
0.35	0.3	2	5	25
0.4	0.3	2	5	25
0.1	0.3	2	6	25
0.15	0.3	2	6	25
0.2	0.3	2	6	25
0.25	0.3	2	6	25
0.3	0.3	2	6	25
0.35	0.3	2	6	25
0.4	0.3	2	6	25
0.1	0.3	2.5	2	25
0.15	0.3	2.5	2	25
0.2	0.3	2.5	2	25
0.25	0.3	2.5	2	25

$\omega = \frac{Q}{v}$	$h = \frac{\omega}{b}$	$\chi = b + 2h$	$\frac{\omega^2}{\chi}$	$\Pi_k = \frac{v^2}{gh}$	$\sqrt{\Pi_k}$	$i = \frac{\Delta h}{L}$	$\Delta = \frac{8g \cdot \omega^2 - M + 2i^2}{Q^2 \cdot \chi - N \log i} \cdot h \cdot \frac{\chi}{b} \sqrt{\Pi_k}$	$\delta = 7\Delta$	uk.Dubina
0.333333	0.166667	2.333333	0.047619	0.055046	0.234619	0.08	0.860890044	6.02623	1.027557
0.5	0.25	2.5	0.1	0.036697	0.191565	0.08	1.054143775	7.379006	1.304144
0.666667	0.333333	2.666667	0.166667	0.027523	0.1659	0.08	1.216958393	8.518709	1.550292
0.833333	0.416667	2.833333	0.245098	0.022018	0.148386	0.08	1.36030793	9.522156	1.776975
1	0.5	3	0.333333	0.018349	0.135457	0.08	1.489821804	10.42875	1.989822
1.166667	0.583333	3.166667	0.429825	0.015727	0.125409	0.08	1.608844884	11.26191	2.192178
1.333333	0.666667	3.333333	0.533333	0.013761	0.117309	0.08	1.719557015	12.0369	2.386224
0.333333	0.166667	2.333333	0.047619	0.055046	0.234619	0.12	1.026183805	7.183287	1.19285
0.5	0.25	2.5	0.1	0.036697	0.191565	0.12	1.25660106	8.796207	1.506601
0.666667	0.333333	2.666667	0.166667	0.027523	0.1659	0.12	1.450752787	10.15527	1.784086
0.833333	0.416667	2.833333	0.245098	0.022018	0.148386	0.12	1.621716857	11.35202	2.038384
1	0.5	3	0.333333	0.018349	0.135457	0.12	1.776201583	12.43341	2.276202
1.166667	0.583333	3.166667	0.429825	0.015727	0.125409	0.12	1.918192701	13.42735	2.501526
1.333333	0.666667	3.333333	0.533333	0.013761	0.117309	0.12	2.050287582	14.35201	2.716954
0.333333	0.166667	2.333333	0.047619	0.055046	0.234619	0.16	1.187532146	8.312725	1.354199
0.5	0.25	2.5	0.1	0.036697	0.191565	0.16	1.45420069	10.1794	1.704201
0.666667	0.333333	2.666667	0.166667	0.027523	0.1659	0.16	1.678908574	11.75236	2.012242
0.833333	0.416667	2.833333	0.245098	0.022018	0.148386	0.16	1.87678868	13.13752	2.293455
1	0.5	3	0.333333	0.018349	0.135457	0.16	2.055603318	14.38922	2.555603
1.166667	0.583333	3.166667	0.429825	0.015727	0.125409	0.16	2.21996438	15.53975	2.803298
1.333333	0.666667	3.333333	0.533333	0.013761	0.117309	0.16	2.37287724	16.61014	3.039544
0.333333	0.166667	2.333333	0.047619	0.055046	0.234619	0.2	1.3522387	9.465671	1.518905
0.5	0.25	2.5	0.1	0.036697	0.191565	0.2	1.655898404	11.59129	1.905898
0.666667	0.333333	2.666667	0.166667	0.027523	0.1659	0.2	1.911779249	13.38245	2.245113
0.833333	0.416667	2.833333	0.245098	0.022018	0.148386	0.2	2.13711271	14.95979	2.553779
1	0.5	3	0.333333	0.018349	0.135457	0.2	2.340737528	16.38516	2.840738
1.166667	0.583333	3.166667	0.429825	0.015727	0.125409	0.2	2.527905127	17.69534	3.111238
1.333333	0.666667	3.333333	0.533333	0.013761	0.117309	0.2	2.702037625	18.91426	3.368704
0.333333	0.166667	2.333333	0.047619	0.055046	0.234619	0.24	1.5249295	10.67451	1.691596
0.5	0.25	2.5	0.1	0.036697	0.191565	0.24	1.867363099	13.07154	2.117363
0.666667	0.333333	2.666667	0.166667	0.027523	0.1659	0.24	2.155914372	15.0914	2.489248
0.833333	0.416667	2.833333	0.245098	0.022018	0.148386	0.24	2.410015694	16.87011	2.826682
1	0.5	3	0.333333	0.018349	0.135457	0.24	2.639634769	18.47744	3.139635
1.166667	0.583333	3.166667	0.429825	0.015727	0.125409	0.24	2.8506938	19.95486	3.434027
1.333333	0.666667	3.333333	0.533333	0.013761	0.117309	0.24	3.047052034	21.32936	3.713719
0.333333	0.133333	2.766667	0.040161	0.068807	0.262312	0.08	0.769572649	5.387009	0.902906
0.5	0.2	2.9	0.086207	0.045872	0.214176	0.08	0.942367805	6.596575	1.142368
0.666667	0.266667	3.033333	0.14652	0.034404	0.185482	0.08	1.087965145	7.615756	1.354632
0.833333	0.333333	3.166667	0.219298	0.027523	0.1659	0.08	1.216172417	8.513207	1.549506

PRILOG BROJ 1

Tip riblje staze:		normalna naizmjenična rebra
M	N	
0.077	18	

Q (m ³ /s)	v (m/s)	b (m)	pret. Δh	pretp. L
0.3	0.3	2.5	2	25
0.35	0.3	2.5	2	25
0.4	0.3	2.5	2	25
0.1	0.3	2.5	3	25
0.15	0.3	2.5	3	25
0.2	0.3	2.5	3	25
0.25	0.3	2.5	3	25
0.3	0.3	2.5	3	25
0.35	0.3	2.5	3	25
0.4	0.3	2.5	3	25
0.1	0.3	2.5	4	25
0.15	0.3	2.5	4	25
0.2	0.3	2.5	4	25
0.25	0.3	2.5	4	25
0.3	0.3	2.5	4	25
0.35	0.3	2.5	4	25
0.4	0.3	2.5	4	25
0.1	0.3	2.5	5	25
0.15	0.3	2.5	5	25
0.2	0.3	2.5	5	25
0.25	0.3	2.5	5	25
0.3	0.3	2.5	5	25
0.35	0.3	2.5	5	25
0.4	0.3	2.5	5	25
0.1	0.3	2.5	6	25
0.15	0.3	2.5	6	25
0.2	0.3	2.5	6	25
0.25	0.3	2.5	6	25
0.3	0.3	2.5	6	25
0.35	0.3	2.5	6	25
0.4	0.3	2.5	6	25
0.1	0.3	3	2	25
0.15	0.3	3	2	25
0.2	0.3	3	2	25
0.25	0.3	3	2	25
0.3	0.3	3	2	25
0.35	0.3	3	2	25
0.4	0.3	3	2	25
0.1	0.3	3	3	25

$\omega = \frac{Q}{v}$	$h = \frac{\omega}{b}$	$\chi = b + 2h$	$\frac{\omega^2}{\chi}$	$\Pi_k = \frac{v^2}{gh}$	$\sqrt{\Pi_k}$	$i = \frac{\Delta h}{L}$	$\Delta = \frac{8g \cdot \omega^2 - M + 2i^2}{Q^2 \cdot \chi - N \log i} \cdot h \cdot \frac{\chi}{b} \cdot \sqrt{\Pi_k}$	$\delta = 7\Delta$	uk.Dubina
1	0.4	3.3	0.30303	0.022936	0.151446	0.08	1.332020536	9.324144	1.732021
1.166667	0.466667	3.433333	0.39644	0.019659	0.140211	0.08	1.438498622	10.06949	1.905165
1.333333	0.533333	3.566667	0.498442	0.017202	0.131156	0.08	1.537554595	10.76288	2.070888
0.333333	0.133333	2.766667	0.040161	0.068807	0.262312	0.12	0.917443604	6.422105	1.050777
0.5	0.2	2.9	0.086207	0.045872	0.214176	0.12	1.123482445	7.864377	1.323482
0.666667	0.266667	3.033333	0.14652	0.034404	0.185482	0.12	1.297110381	9.079773	1.563777
0.833333	0.333333	3.166667	0.219298	0.027523	0.1659	0.12	1.450017386	10.15012	1.783351
1	0.4	3.3	0.30303	0.022936	0.151446	0.12	1.588199638	11.1174	1.9882
1.166667	0.466667	3.433333	0.39644	0.019659	0.140211	0.12	1.715219636	12.00654	2.181886
1.333333	0.533333	3.566667	0.498442	0.017202	0.131156	0.12	1.833398862	12.83379	2.366732
0.333333	0.133333	2.766667	0.040161	0.068807	0.262312	0.16	1.061737207	7.43216	1.195071
0.5	0.2	2.9	0.086207	0.045872	0.214176	0.16	1.30019748	9.101382	1.500197
0.666667	0.266667	3.033333	0.14652	0.034404	0.185482	0.16	1.501154301	10.50808	1.767821
0.833333	0.333333	3.166667	0.219298	0.027523	0.1659	0.16	1.678135334	11.74695	2.011469
1	0.4	3.3	0.30303	0.022936	0.151446	0.16	1.838079276	12.86655	2.238079
1.166667	0.466667	3.433333	0.39644	0.019659	0.140211	0.16	1.985108553	13.89576	2.451775
1.333333	0.533333	3.566667	0.498442	0.017202	0.131156	0.16	2.121909488	14.85337	2.655243
0.333333	0.133333	2.766667	0.040161	0.068807	0.262312	0.2	1.209006252	8.463044	1.34234
0.5	0.2	2.9	0.086207	0.045872	0.214176	0.2	1.48054603	10.36382	1.680546
0.666667	0.266667	3.033333	0.14652	0.034404	0.185482	0.2	1.709381558	11.96567	1.976048
0.833333	0.333333	3.166667	0.219298	0.027523	0.1659	0.2	1.910916658	13.37642	2.24425
1	0.4	3.3	0.30303	0.022936	0.151446	0.2	2.093052339	14.65137	2.493052
1.166667	0.466667	3.433333	0.39644	0.019659	0.140211	0.2	2.260482745	15.82338	2.727149
1.333333	0.533333	3.566667	0.498442	0.017202	0.131156	0.2	2.416266743	16.91387	2.9496
0.333333	0.133333	2.766667	0.040161	0.068807	0.262312	0.24	1.36339444	9.543761	1.496728
0.5	0.2	2.9	0.086207	0.045872	0.214176	0.24	1.669605356	11.68724	1.869605
0.666667	0.266667	3.033333	0.14652	0.034404	0.185482	0.24	1.927657499	13.4936	2.194324
0.833333	0.333333	3.166667	0.219298	0.027523	0.1659	0.24	2.15492196	15.08445	2.488255
1	0.4	3.3	0.30303	0.022936	0.151446	0.24	2.360308832	16.52216	2.760309
1.166667	0.466667	3.433333	0.39644	0.019659	0.140211	0.24	2.549111788	17.84378	3.015778
1.333333	0.533333	3.566667	0.498442	0.017202	0.131156	0.24	2.724780379	19.07346	3.258114
0.333333	0.111111	3.222222	0.034483	0.082569	0.287348	0.08	0.702107052	4.914749	0.813218
0.5	0.166667	3.333333	0.075	0.055046	0.234619	0.08	0.859778507	6.01845	1.026445
0.666667	0.222222	3.444444	0.129032	0.041284	0.203186	0.08	0.992644095	6.948509	1.214866
0.833333	0.277778	3.555556	0.195313	0.033028	0.181735	0.08	1.109650394	7.767553	1.387428
1	0.333333	3.666667	0.272727	0.027523	0.1659	0.08	1.215386442	8.507705	1.54872
1.166667	0.388889	3.777778	0.360294	0.023591	0.153594	0.08	1.312578741	9.188051	1.701468
1.333333	0.444444	3.888889	0.457143	0.020642	0.143674	0.08	1.403004016	9.821028	1.847448
0.333333	0.111111	3.222222	0.034483	0.082569	0.287348	0.12	0.837120752	5.859845	0.948232

PRILOG BROJ 1

Tip riblje staze:		normalna naizmjenična rebra
M	N	
0.077	18	

Q (m ³ /s)	v (m/s)	b (m)	pret. Δh	pretp. L
0.15	0.3	3	3	25
0.2	0.3	3	3	25
0.25	0.3	3	3	25
0.3	0.3	3	3	25
0.35	0.3	3	3	25
0.4	0.3	3	3	25
0.1	0.3	3	4	25
0.15	0.3	3	4	25
0.2	0.3	3	4	25
0.25	0.3	3	4	25
0.3	0.3	3	4	25
0.35	0.3	3	4	25
0.4	0.3	3	4	25
0.1	0.3	3	5	25
0.15	0.3	3	5	25
0.2	0.3	3	5	25
0.25	0.3	3	5	25
0.3	0.3	3	5	25
0.35	0.3	3	5	25
0.4	0.3	3	5	25
0.1	0.3	3	6	25
0.15	0.3	3	6	25
0.2	0.3	3	6	25
0.25	0.3	3	6	25
0.3	0.3	3	6	25
0.35	0.3	3	6	25
0.4	0.3	3	6	25
0.1	0.3	3.5	2	25
0.15	0.3	3.5	2	25
0.2	0.3	3.5	2	25
0.25	0.3	3.5	2	25
0.3	0.3	3.5	2	25
0.35	0.3	3.5	2	25
0.4	0.3	3.5	2	25
0.1	0.3	3.5	3	25
0.15	0.3	3.5	3	25
0.2	0.3	3.5	3	25
0.25	0.3	3.5	3	25
0.3	0.3	3.5	3	25

$\omega = \frac{Q}{v}$	$h = \frac{\omega}{b}$	$\chi = b + 2h$	$\frac{\omega^2}{\chi}$	$\Pi_k = \frac{v^2}{gh}$	$\sqrt{\Pi_k}$	$i = \frac{\Delta h}{L}$	$\Delta = \frac{8g \cdot \omega^2 - M + 2i^2}{Q^2 \cdot \frac{\chi}{N \log i} - h \cdot \frac{\chi}{b} \sqrt{\Pi_k}}$	$\delta = 7\Delta$	uk.Dubina
0.5	0.166667	3.333333	0.075	0.055046	0.234619	0.12	1.025143791	7.176007	1.19181
0.666667	0.222222	3.444444	0.129032	0.041284	0.203186	0.12	1.183600654	8.285205	1.405823
0.833333	0.277778	3.555556	0.195313	0.033028	0.181735	0.12	1.323156577	9.262096	1.600934
1	0.333333	3.666667	0.272727	0.027523	0.1659	0.12	1.449281986	10.14497	1.782615
1.166667	0.388889	3.777778	0.360294	0.023591	0.153594	0.12	1.565226942	10.95659	1.954116
1.333333	0.444444	3.888889	0.457143	0.020642	0.143674	0.12	1.673109282	11.71176	2.117554
0.333333	0.111111	3.222222	0.034483	0.082569	0.287348	0.16	0.968822284	6.781756	1.079933
0.5	0.166667	3.333333	0.075	0.055046	0.234619	0.16	1.18643862	8.30507	1.353105
0.666667	0.222222	3.444444	0.129032	0.041284	0.203186	0.16	1.369841014	9.588887	1.592063
0.833333	0.277778	3.555556	0.195313	0.033028	0.181735	0.16	1.531371953	10.7196	1.80915
1	0.333333	3.666667	0.272727	0.027523	0.1659	0.16	1.677362095	11.74153	2.010695
1.166667	0.388889	3.777778	0.360294	0.023591	0.153594	0.16	1.811572533	12.68101	2.200461
1.333333	0.444444	3.888889	0.457143	0.020642	0.143674	0.16	1.936454087	13.55518	2.380899
0.333333	0.111111	3.222222	0.034483	0.082569	0.287348	0.2	1.103212912	7.72249	1.214324
0.5	0.166667	3.333333	0.075	0.055046	0.234619	0.2	1.351018813	9.457132	1.517685
0.666667	0.222222	3.444444	0.129032	0.041284	0.203186	0.2	1.559865639	10.91906	1.782088
0.833333	0.277778	3.555556	0.195313	0.033028	0.181735	0.2	1.743807817	12.20665	2.021586
1	0.333333	3.666667	0.272727	0.027523	0.1659	0.2	1.910054067	13.37038	2.243387
1.166667	0.388889	3.777778	0.360294	0.023591	0.153594	0.2	2.062887143	14.44021	2.451776
1.333333	0.444444	3.888889	0.457143	0.020642	0.143674	0.2	2.205097778	15.43568	2.649542
0.333333	0.111111	3.222222	0.034483	0.082569	0.287348	0.24	1.24408111	8.708568	1.355192
0.5	0.166667	3.333333	0.075	0.055046	0.234619	0.24	1.523526017	10.66468	1.690193
0.666667	0.222222	3.444444	0.129032	0.041284	0.203186	0.24	1.759036245	12.31325	1.981258
0.833333	0.277778	3.555556	0.195313	0.033028	0.181735	0.24	1.966460988	13.76523	2.244239
1	0.333333	3.666667	0.272727	0.027523	0.1659	0.24	2.153929548	15.07751	2.487263
1.166667	0.388889	3.777778	0.360294	0.023591	0.153594	0.24	2.326271607	16.2839	2.71516
1.333333	0.444444	3.888889	0.457143	0.020642	0.143674	0.24	2.486634302	17.40644	2.931079
0.333333	0.095238	3.690476	0.030108	0.09633	0.310371	0.08	0.649631374	4.54742	0.744869
0.5	0.142857	3.785714	0.066038	0.06422	0.253417	0.08	0.795534686	5.568743	0.938392
0.666667	0.190476	3.880952	0.114519	0.048165	0.219466	0.08	0.91849116	6.429438	1.108967
0.833333	0.238095	3.97619	0.174651	0.038532	0.196296	0.08	1.026777808	7.187445	1.264873
1	0.285714	4.071429	0.245614	0.03211	0.179193	0.08	1.124640129	7.872481	1.410354
1.166667	0.333333	4.166667	0.326667	0.027523	0.1659	0.08	1.214600467	8.502203	1.547934
1.333333	0.380952	4.261905	0.417132	0.024083	0.155186	0.08	1.29830247	9.088117	1.679255
0.333333	0.095238	3.690476	0.030108	0.09633	0.310371	0.12	0.774655088	5.422586	0.869893
0.5	0.142857	3.785714	0.066038	0.06422	0.253417	0.12	0.948663145	6.640642	1.09152
0.666667	0.190476	3.880952	0.114519	0.048165	0.219466	0.12	1.095315957	7.667212	1.285792
0.833333	0.238095	3.97619	0.174651	0.038532	0.196296	0.12	1.224482082	8.571375	1.462577
1	0.285714	4.071429	0.245614	0.03211	0.179193	0.12	1.34122323	9.388563	1.626938

Tip riblje staze:		normalna naizmjenična rebra
M	N	
0.077	18	

Q (m ³ /s)	v (m/s)	b (m)	pret. Δh	pretp. L
0.35	0.3	3.5	3	25
0.4	0.3	3.5	3	25
0.1	0.3	3.5	4	25
0.15	0.3	3.5	4	25
0.2	0.3	3.5	4	25
0.25	0.3	3.5	4	25
0.3	0.3	3.5	4	25
0.35	0.3	3.5	4	25
0.4	0.3	3.5	4	25
0.1	0.3	3.5	5	25
0.15	0.3	3.5	5	25
0.2	0.3	3.5	5	25
0.25	0.3	3.5	5	25
0.3	0.3	3.5	5	25
0.35	0.3	3.5	5	25
0.4	0.3	3.5	5	25
0.1	0.3	3.5	6	25
0.15	0.3	3.5	6	25
0.2	0.3	3.5	6	25
0.25	0.3	3.5	6	25
0.3	0.3	3.5	6	25
0.35	0.3	3.5	6	25
0.4	0.3	3.5	6	25
0.1	0.3	4	2	25
0.15	0.3	4	2	25
0.2	0.3	4	2	25
0.25	0.3	4	2	25
0.3	0.3	4	2	25
0.35	0.3	4	2	25
0.4	0.3	4	2	25
0.1	0.3	4	3	25
0.15	0.3	4	3	25
0.2	0.3	4	3	25
0.25	0.3	4	3	25
0.3	0.3	4	3	25
0.35	0.3	4	3	25
0.4	0.3	4	3	25
0.1	0.3	4	4	25
0.15	0.3	4	4	25

$\omega = \frac{Q}{v}$	$h = \frac{\omega}{b}$	$\chi = b + 2h$	$\frac{\omega^2}{\chi}$	$\Pi_k = \frac{v^2}{gh}$	$\sqrt{\Pi_k}$	$i = \frac{\Delta h}{L}$	$\Delta = \frac{8g \cdot \omega^2 - M + 2i^2}{Q^2 \cdot \chi - N \log i} \cdot h \cdot \frac{\chi}{b} \cdot \sqrt{\Pi_k}$	$\delta = 7\Delta$	uk.Dubina
1.166667	0.333333	4.166667	0.326667	0.027523	0.1659	0.12	1.448546585	10.13983	1.78188
1.333333	0.380952	4.261905	0.417132	0.024083	0.155186	0.12	1.54841169	10.83888	1.929364
0.333333	0.095238	3.690476	0.030108	0.09633	0.310371	0.16	0.896568071	6.275976	0.991806
0.5	0.142857	3.785714	0.066038	0.06422	0.253417	0.16	1.097970727	7.685795	1.240828
0.666667	0.190476	3.880952	0.114519	0.048165	0.219466	0.16	1.267716054	8.874012	1.458192
0.833333	0.238095	3.97619	0.174651	0.038532	0.196296	0.16	1.417225159	9.920576	1.65532
1	0.285714	4.071429	0.245614	0.03211	0.179193	0.16	1.552356019	10.86649	1.83807
1.166667	0.333333	4.166667	0.326667	0.027523	0.1659	0.16	1.676588855	11.73612	2.009922
1.333333	0.380952	4.261905	0.417132	0.024083	0.155186	0.16	1.792191425	12.54534	2.173144
0.333333	0.095238	3.690476	0.030108	0.09633	0.310371	0.2	1.020944888	7.146614	1.116183
0.5	0.142857	3.785714	0.066038	0.06422	0.253417	0.2	1.250289454	8.752026	1.393147
0.666667	0.190476	3.880952	0.114519	0.048165	0.219466	0.2	1.443585705	10.1051	1.634062
0.833333	0.238095	3.97619	0.174651	0.038532	0.196296	0.2	1.613839022	11.29687	1.851934
1	0.285714	4.071429	0.245614	0.03211	0.179193	0.2	1.767719958	12.37404	2.053434
1.166667	0.333333	4.166667	0.326667	0.027523	0.1659	0.2	1.909191477	13.36434	2.242525
1.333333	0.380952	4.261905	0.417132	0.024083	0.155186	0.2	2.040835893	14.28585	2.421788
0.333333	0.095238	3.690476	0.030108	0.09633	0.310371	0.24	1.151298511	8.05909	1.246537
0.5	0.142857	3.785714	0.066038	0.06422	0.253417	0.24	1.409923198	9.869462	1.55278
0.666667	0.190476	3.880952	0.114519	0.048165	0.219466	0.24	1.627896181	11.39527	1.818372
0.833333	0.238095	3.97619	0.174651	0.038532	0.196296	0.24	1.819883501	12.73918	2.057979
1	0.285714	4.071429	0.245614	0.03211	0.179193	0.24	1.993407482	13.95385	2.279122
1.166667	0.333333	4.166667	0.326667	0.027523	0.1659	0.24	2.152937135	15.07056	2.48627
1.333333	0.380952	4.261905	0.417132	0.024083	0.155186	0.24	2.301384528	16.10969	2.682337
0.333333	0.083333	4.166667	0.026667	0.110092	0.331801	0.08	0.607300233	4.251102	0.690634
0.5	0.125	4.25	0.058824	0.073394	0.270914	0.08	0.743707628	5.205953	0.868708
0.666667	0.166667	4.333333	0.102564	0.055046	0.234619	0.08	0.85866697	6.010669	1.025334
0.833333	0.208333	4.416667	0.157233	0.044037	0.209849	0.08	0.959915296	6.719407	1.168249
1	0.25	4.5	0.222222	0.036697	0.191565	0.08	1.051421076	7.359948	1.301421
1.166667	0.291667	4.583333	0.29697	0.031455	0.177355	0.08	1.135542025	7.948794	1.427209
1.333333	0.333333	4.666667	0.380952	0.027523	0.1659	0.08	1.213814491	8.496701	1.547148
0.333333	0.083333	4.166667	0.026667	0.110092	0.331801	0.12	0.724273293	5.069913	0.807607
0.5	0.125	4.25	0.058824	0.073394	0.270914	0.12	0.886974944	6.208825	1.011975
0.666667	0.166667	4.333333	0.102564	0.055046	0.234619	0.12	1.024103778	7.168726	1.19077
0.833333	0.208333	4.416667	0.157233	0.044037	0.209849	0.12	1.144885934	8.014202	1.353219
1	0.25	4.5	0.222222	0.036697	0.191565	0.12	1.254053558	8.778375	1.504054
1.166667	0.291667	4.583333	0.29697	0.031455	0.177355	0.12	1.354418004	9.480926	1.646085
1.333333	0.333333	4.666667	0.380952	0.027523	0.1659	0.12	1.447811185	10.13468	1.781145
0.333333	0.083333	4.166667	0.026667	0.110092	0.331801	0.16	0.838294427	5.868061	0.921628
0.5	0.125	4.25	0.058824	0.073394	0.270914	0.16	1.026617882	7.186325	1.151618

PRILOG BROJ 1

Tip riblje staze:		normalna naizmjenična rebra
M	N	
0.077	18	

Q (m ³ /s)	v (m/s)	b (m)	pret. Δh	pretp. L
0.2	0.3	4	4	25
0.25	0.3	4	4	25
0.3	0.3	4	4	25
0.35	0.3	4	4	25
0.4	0.3	4	4	25
0.1	0.3	4	5	25
0.15	0.3	4	5	25
0.2	0.3	4	5	25
0.25	0.3	4	5	25
0.3	0.3	4	5	25
0.35	0.3	4	5	25
0.4	0.3	4	5	25
0.1	0.3	4	6	25
0.15	0.3	4	6	25
0.2	0.3	4	6	25
0.25	0.3	4	6	25
0.3	0.3	4	6	25
0.35	0.3	4	6	25
0.4	0.3	4	6	25

$\omega = \frac{Q}{v}$	$h = \frac{\omega}{b}$	$\chi = b + 2h$	$\frac{\omega^2}{\chi}$	$\Pi_k = \frac{v^2}{gh}$	$\sqrt{\Pi_k}$	$i = \frac{\Delta h}{L}$	$\Delta = \frac{8g \cdot \omega^2 - M + 2i^2}{Q^2 \cdot \chi - N \log i} \cdot h \cdot \frac{\chi}{b} \cdot \sqrt{\Pi_k}$	$\delta = 7\Delta$	uk.Dubina
0.666667	0.166667	4.333333	0.102564	0.055046	0.234619	0.16	1.185345094	8.297416	1.352012
0.833333	0.208333	4.416667	0.157233	0.044037	0.209849	0.16	1.325154221	9.27608	1.533488
1	0.25	4.5	0.222222	0.036697	0.191565	0.16	1.45152211	10.16065	1.701522
1.166667	0.291667	4.583333	0.29697	0.031455	0.177355	0.16	1.567702519	10.97392	1.859369
1.333333	0.333333	4.666667	0.380952	0.027523	0.1659	0.16	1.675815615	11.73071	2.009149
0.333333	0.083333	4.166667	0.026667	0.110092	0.331801	0.2	0.954595738	6.68217	1.037929
0.5	0.125	4.25	0.058824	0.073394	0.270914	0.2	1.169048197	8.183337	1.294048
0.666667	0.166667	4.333333	0.102564	0.055046	0.234619	0.2	1.349798925	9.448592	1.516466
0.833333	0.208333	4.416667	0.157233	0.044037	0.209849	0.2	1.50900742	10.56305	1.717341
1	0.25	4.5	0.222222	0.036697	0.191565	0.2	1.652910303	11.57037	1.90291
1.166667	0.291667	4.583333	0.29697	0.031455	0.177355	0.2	1.785212698	12.49649	2.076879
1.333333	0.333333	4.666667	0.380952	0.027523	0.1659	0.2	1.908328886	13.3583	2.241662
0.333333	0.083333	4.166667	0.026667	0.110092	0.331801	0.24	1.076468568	7.53528	1.159802
0.5	0.125	4.25	0.058824	0.073394	0.270914	0.24	1.31829807	9.228086	1.443298
0.666667	0.166667	4.333333	0.102564	0.055046	0.234619	0.24	1.522122534	10.65486	1.688789
0.833333	0.208333	4.416667	0.157233	0.044037	0.209849	0.24	1.701653966	11.91158	1.909987
1	0.25	4.5	0.222222	0.036697	0.191565	0.24	1.863925283	13.04748	2.113925
1.166667	0.291667	4.583333	0.29697	0.031455	0.177355	0.24	2.013114687	14.0918	2.304781
1.333333	0.333333	4.666667	0.380952	0.027523	0.1659	0.24	2.151944723	15.06361	2.485278

PRILOG BROJ 1

Tip riblje staze:		normalna naizmjenična rebra
M	N	
0.077	18	

Q (m ³ /s)	v (m/s)	b (m)	pret. Δh	pretp. L
0.1	0.5	2	2	25
0.15	0.5	2	2	25
0.2	0.5	2	2	25
0.25	0.5	2	2	25
0.3	0.5	2	2	25
0.35	0.5	2	2	25
0.4	0.5	2	2	25
0.1	0.5	2	3	25
0.15	0.5	2	3	25
0.2	0.5	2	3	25
0.25	0.5	2	3	25
0.3	0.5	2	3	25
0.35	0.5	2	3	25
0.4	0.5	2	3	25
0.1	0.5	2	4	25
0.15	0.5	2	4	25
0.2	0.5	2	4	25
0.25	0.5	2	4	25
0.3	0.5	2	4	25
0.35	0.5	2	4	25
0.4	0.5	2	4	25
0.1	0.5	2	5	25
0.15	0.5	2	5	25
0.2	0.5	2	5	25
0.25	0.5	2	5	25
0.3	0.5	2	5	25
0.35	0.5	2	5	25
0.4	0.5	2	5	25
0.1	0.5	2	6	25
0.15	0.5	2	6	25
0.2	0.5	2	6	25
0.25	0.5	2	6	25
0.3	0.5	2	6	25
0.35	0.5	2	6	25
0.4	0.5	2	6	25
0.1	0.5	2.5	2	25
0.15	0.5	2.5	2	25
0.2	0.5	2.5	2	25
0.25	0.5	2.5	2	25

$\omega = \frac{Q}{v}$	$h = \frac{\omega}{b}$	$\chi = b + 2h$	$\frac{\omega^2}{\chi}$	$\Pi_k = \frac{v^2}{gh}$	$\sqrt{\Pi_k}$	$i = \frac{\Delta h}{L}$	$\Delta = \frac{8g \cdot \omega^2 - M + 2i^2}{Q^2 \cdot \chi - N \log i} \cdot h \cdot \frac{\chi}{b} \cdot \sqrt{\Pi_k}$	$\delta = 7\Delta$	uk.Dubina
0.2	0.1	2.2	0.018182	0.254842	0.504819	0.08	0.398153953	2.787078	0.498154
0.3	0.15	2.3	0.03913	0.169895	0.412183	0.08	0.487461262	3.412229	0.637461
0.4	0.2	2.4	0.066667	0.127421	0.356961	0.08	0.562668844	3.938682	0.762669
0.5	0.25	2.5	0.1	0.101937	0.319275	0.08	0.628856	4.401992	0.878856
0.6	0.3	2.6	0.138462	0.084947	0.291457	0.08	0.688628686	4.820401	0.988629
0.7	0.35	2.7	0.181481	0.072812	0.269837	0.08	0.74353553	5.204749	1.093536
0.8	0.4	2.8	0.228571	0.06371	0.252409	0.08	0.794585919	5.562101	1.194586
0.2	0.1	2.2	0.018182	0.254842	0.504819	0.12	0.475101128	3.325708	0.575101
0.3	0.15	2.3	0.03913	0.169895	0.412183	0.12	0.58171323	4.071993	0.731713
0.4	0.2	2.4	0.066667	0.127421	0.356961	0.12	0.6715147	4.700603	0.871515
0.5	0.25	2.5	0.1	0.101937	0.319275	0.12	0.750563967	5.253948	1.000564
0.6	0.3	2.6	0.138462	0.084947	0.291457	0.12	0.821969077	5.753784	1.121969
0.7	0.35	2.7	0.181481	0.072812	0.269837	0.12	0.887576888	6.213038	1.237577
0.8	0.4	2.8	0.228571	0.06371	0.252409	0.12	0.948591075	6.640138	1.348591
0.2	0.1	2.2	0.018182	0.254842	0.504819	0.16	0.549995106	3.849966	0.649995
0.3	0.15	2.3	0.03913	0.169895	0.412183	0.16	0.673430784	4.714015	0.823431
0.4	0.2	2.4	0.066667	0.127421	0.356961	0.16	0.777411239	5.441879	0.977411
0.5	0.25	2.5	0.1	0.101937	0.319275	0.16	0.868948974	6.082643	1.118949
0.6	0.3	2.6	0.138462	0.084947	0.291457	0.16	0.951641389	6.66149	1.251641
0.7	0.35	2.7	0.181481	0.072812	0.269837	0.16	1.027626068	7.193382	1.377626
0.8	0.4	2.8	0.228571	0.06371	0.252409	0.16	1.098296129	7.688073	1.498296
0.2	0.1	2.2	0.018182	0.254842	0.504819	0.2	0.626321936	4.384254	0.726322
0.3	0.15	2.3	0.03913	0.169895	0.412183	0.2	0.766891697	5.368242	0.916892
0.4	0.2	2.4	0.066667	0.127421	0.356961	0.2	0.885307536	6.197153	1.085308
0.5	0.25	2.5	0.1	0.101937	0.319275	0.2	0.989554907	6.926884	1.239555
0.6	0.3	2.6	0.138462	0.084947	0.291457	0.2	1.083730314	7.586112	1.38373
0.7	0.35	2.7	0.181481	0.072812	0.269837	0.2	1.170267894	8.191875	1.520268
0.8	0.4	2.8	0.228571	0.06371	0.252409	0.2	1.25075403	8.755278	1.650754
0.2	0.1	2.2	0.018182	0.254842	0.504819	0.24	0.706259018	4.943813	0.806259
0.3	0.15	2.3	0.03913	0.169895	0.412183	0.24	0.864765201	6.053356	1.014765
0.4	0.2	2.4	0.066667	0.127421	0.356961	0.24	0.998288603	6.98802	1.198289
0.5	0.25	2.5	0.1	0.101937	0.319275	0.24	1.115834104	7.810839	1.365834
0.6	0.3	2.6	0.138462	0.084947	0.291457	0.24	1.22202119	8.554148	1.522021
0.7	0.35	2.7	0.181481	0.072812	0.269837	0.24	1.31959477	9.237163	1.669595
0.8	0.4	2.8	0.228571	0.06371	0.252409	0.24	1.410343771	9.872406	1.810344
0.2	0.08	2.66	0.015038	0.318552	0.564405	0.08	0.355529315	2.488705	0.435529
0.3	0.12	2.74	0.032847	0.212368	0.460834	0.08	0.435306949	3.047149	0.555307
0.4	0.16	2.82	0.056738	0.159276	0.399094	0.08	0.502503958	3.517528	0.662504
0.5	0.2	2.9	0.086207	0.127421	0.356961	0.08	0.561654154	3.931579	0.761654

PRILOG BROJ 1

Tip riblje staze:		normalna naizmjenična rebra
M	N	
0.077	18	

Q (m ³ /s)	v (m/s)	b (m)	pret. Δh	pretp. L
0.3	0.5	2.5	2	25
0.35	0.5	2.5	2	25
0.4	0.5	2.5	2	25
0.1	0.5	2.5	3	25
0.15	0.5	2.5	3	25
0.2	0.5	2.5	3	25
0.25	0.5	2.5	3	25
0.3	0.5	2.5	3	25
0.35	0.5	2.5	3	25
0.4	0.5	2.5	3	25
0.1	0.5	2.5	4	25
0.15	0.5	2.5	4	25
0.2	0.5	2.5	4	25
0.25	0.5	2.5	4	25
0.3	0.5	2.5	4	25
0.35	0.5	2.5	4	25
0.4	0.5	2.5	4	25
0.1	0.5	2.5	5	25
0.15	0.5	2.5	5	25
0.2	0.5	2.5	5	25
0.25	0.5	2.5	5	25
0.3	0.5	2.5	5	25
0.35	0.5	2.5	5	25
0.4	0.5	2.5	5	25
0.1	0.5	2.5	6	25
0.15	0.5	2.5	6	25
0.2	0.5	2.5	6	25
0.25	0.5	2.5	6	25
0.3	0.5	2.5	6	25
0.35	0.5	2.5	6	25
0.4	0.5	2.5	6	25
0.1	0.5	3	2	25
0.15	0.5	3	2	25
0.2	0.5	3	2	25
0.25	0.5	3	2	25
0.3	0.5	3	2	25
0.35	0.5	3	2	25
0.4	0.5	3	2	25
0.1	0.5	3	3	25

$\omega = \frac{Q}{v}$	$h = \frac{\omega}{b}$	$\chi = b + 2h$	$\frac{\omega^2}{\chi}$	$\Pi_k = \frac{v^2}{gh}$	$\sqrt{\Pi_k}$	$i = \frac{\Delta h}{L}$	$\Delta = \frac{8g \cdot \omega^2 - M + 2i^2}{Q^2 \cdot \chi - N \log i} \cdot h \cdot \frac{\chi}{b} \sqrt{\Pi_k}$	$\delta = 7\Delta$	uk.Dubina
0.6	0.24	2.98	0.120805	0.106184	0.325859	0.08	0.615083453	4.305584	0.855083
0.7	0.28	3.06	0.160131	0.091015	0.301687	0.08	0.664173966	4.649218	0.944174
0.8	0.32	3.14	0.203822	0.079638	0.282202	0.08	0.709826477	4.968785	1.029826
0.2	0.08	2.66	0.015038	0.318552	0.564405	0.12	0.424390952	2.970737	0.504391
0.3	0.12	2.74	0.032847	0.212368	0.460834	0.12	0.519652978	3.637571	0.639653
0.4	0.16	2.82	0.056738	0.159276	0.399094	0.12	0.599907706	4.199354	0.759908
0.5	0.2	2.9	0.086207	0.127421	0.356961	0.12	0.670565302	4.693957	0.870565
0.6	0.24	2.98	0.120805	0.106184	0.325859	0.12	0.734401082	5.140808	0.974401
0.7	0.28	3.06	0.160131	0.091015	0.301687	0.12	0.793064096	5.551449	1.073064
0.8	0.32	3.14	0.203822	0.079638	0.282202	0.12	0.847629036	5.933403	1.167629
0.2	0.08	2.66	0.015038	0.318552	0.564405	0.16	0.491349738	3.439448	0.57135
0.3	0.12	2.74	0.032847	0.212368	0.460834	0.16	0.601654354	4.21158	0.721654
0.4	0.16	2.82	0.056738	0.159276	0.399094	0.16	0.694587748	4.862114	0.854588
0.5	0.2	2.9	0.086207	0.127421	0.356961	0.16	0.776412991	5.434891	0.976413
0.6	0.24	2.98	0.120805	0.106184	0.325859	0.16	0.850342854	5.9524	1.090343
0.7	0.28	3.06	0.160131	0.091015	0.301687	0.16	0.918286274	6.428004	1.198286
0.8	0.32	3.14	0.203822	0.079638	0.282202	0.16	0.981487289	6.870411	1.301487
0.2	0.08	2.66	0.015038	0.318552	0.564405	0.2	0.559551411	3.91686	0.639551
0.3	0.12	2.74	0.032847	0.212368	0.460834	0.2	0.685169707	4.796188	0.80517
0.4	0.16	2.82	0.056738	0.159276	0.399094	0.2	0.791006464	5.537045	0.951006
0.5	0.2	2.9	0.086207	0.127421	0.356961	0.2	0.884193936	6.189358	1.084194
0.6	0.24	2.98	0.120805	0.106184	0.325859	0.2	0.968390746	6.778735	1.208391
0.7	0.28	3.06	0.160131	0.091015	0.301687	0.2	1.045770733	7.320395	1.325771
0.8	0.32	3.14	0.203822	0.079638	0.282202	0.2	1.117750562	7.824254	1.437751
0.2	0.08	2.66	0.015038	0.318552	0.564405	0.24	0.630951793	4.416663	0.710952
0.3	0.12	2.74	0.032847	0.212368	0.460834	0.24	0.772596187	5.408173	0.892596
0.4	0.16	2.82	0.056738	0.159276	0.399094	0.24	0.891933882	6.243537	1.051934
0.5	0.2	2.9	0.086207	0.127421	0.356961	0.24	0.997007404	6.979052	1.197007
0.6	0.24	2.98	0.120805	0.106184	0.325859	0.24	1.091942334	7.643596	1.331942
0.7	0.28	3.06	0.160131	0.091015	0.301687	0.24	1.179189971	8.25433	1.45919
0.8	0.32	3.14	0.203822	0.079638	0.282202	0.24	1.260347808	8.822435	1.580348
0.2	0.066667	3.133333	0.012766	0.382263	0.618274	0.08	0.323997789	2.267985	0.390664
0.3	0.1	3.2	0.028125	0.254842	0.504819	0.08	0.396718964	2.777033	0.496719
0.4	0.133333	3.266667	0.04898	0.191131	0.437186	0.08	0.457981136	3.205868	0.591314
0.5	0.166667	3.333333	0.075	0.152905	0.391031	0.08	0.511914972	3.583405	0.678582
0.6	0.2	3.4	0.105882	0.127421	0.356961	0.08	0.560639464	3.924476	0.760639
0.7	0.233333	3.466667	0.141346	0.109218	0.330481	0.08	0.6054137	4.237896	0.838747
0.8	0.266667	3.533333	0.181132	0.095566	0.309137	0.08	0.647058247	4.529408	0.913725
0.2	0.066667	3.133333	0.012766	0.382263	0.618274	0.12	0.386895261	2.708267	0.453562

PRILOG BROJ 1

Tip riblje staze:		normalna naizmjenična rebra
M	N	
0.077	18	

Q (m ³ /s)	v (m/s)	b (m)	pret. Δh	pretp. L
0.15	0.5	3	3	25
0.2	0.5	3	3	25
0.25	0.5	3	3	25
0.3	0.5	3	3	25
0.35	0.5	3	3	25
0.4	0.5	3	3	25
0.1	0.5	3	4	25
0.15	0.5	3	4	25
0.2	0.5	3	4	25
0.25	0.5	3	4	25
0.3	0.5	3	4	25
0.35	0.5	3	4	25
0.4	0.5	3	4	25
0.1	0.5	3	5	25
0.15	0.5	3	5	25
0.2	0.5	3	5	25
0.25	0.5	3	5	25
0.3	0.5	3	5	25
0.35	0.5	3	5	25
0.4	0.5	3	5	25
0.1	0.5	3	6	25
0.15	0.5	3	6	25
0.2	0.5	3	6	25
0.25	0.5	3	6	25
0.3	0.5	3	6	25
0.35	0.5	3	6	25
0.4	0.5	3	6	25
0.1	0.5	3.5	2	25
0.15	0.5	3.5	2	25
0.2	0.5	3.5	2	25
0.25	0.5	3.5	2	25
0.3	0.5	3.5	2	25
0.35	0.5	3.5	2	25
0.4	0.5	3.5	2	25
0.1	0.5	3.5	3	25
0.15	0.5	3.5	3	25
0.2	0.5	3.5	3	25
0.25	0.5	3.5	3	25
0.3	0.5	3.5	3	25

$\omega = \frac{Q}{v}$	$h = \frac{\omega}{b}$	$\chi = b + 2h$	$\frac{\omega^2}{\chi}$	$\Pi_k = \frac{v^2}{gh}$	$\sqrt{\Pi_k}$	$i = \frac{\Delta h}{L}$	$\Delta = \frac{8g \cdot \omega^2 - M + 2i^2}{Q^2 \cdot \chi - N \log i} \cdot h \cdot \frac{\chi}{b} \cdot \sqrt{\Pi_k}$	$\delta = 7\Delta$	uk.Dubina
0.3	0.1	3.2	0.028125	0.254842	0.504819	0.12	0.473758477	3.316309	0.573758
0.4	0.133333	3.266667	0.04898	0.191131	0.437186	0.12	0.546945811	3.828621	0.680279
0.5	0.166667	3.333333	0.075	0.152905	0.391031	0.12	0.61138845	4.279719	0.778055
0.6	0.2	3.4	0.105882	0.127421	0.356961	0.12	0.669615904	4.687311	0.869616
0.7	0.233333	3.466667	0.141346	0.109218	0.330481	0.12	0.723131112	5.061918	0.956464
0.8	0.266667	3.533333	0.181132	0.095566	0.309137	0.12	0.772913506	5.410395	1.03958
0.2	0.066667	3.133333	0.012766	0.382263	0.618274	0.16	0.447993291	3.135953	0.51466
0.3	0.1	3.2	0.028125	0.254842	0.504819	0.16	0.54858337	3.840084	0.648583
0.4	0.133333	3.266667	0.04898	0.191131	0.437186	0.16	0.633340838	4.433386	0.766674
0.5	0.166667	3.333333	0.075	0.152905	0.391031	0.16	0.70797508	4.955826	0.874642
0.6	0.2	3.4	0.105882	0.127421	0.356961	0.16	0.775414743	5.427903	0.975415
0.7	0.233333	3.466667	0.141346	0.109218	0.330481	0.16	0.837399883	5.861799	1.070733
0.8	0.266667	3.533333	0.181132	0.095566	0.309137	0.16	0.895064441	6.265451	1.161731
0.2	0.066667	3.133333	0.012766	0.382263	0.618274	0.2	0.51018957	3.571327	0.576856
0.3	0.1	3.2	0.028125	0.254842	0.504819	0.2	0.624747068	4.373229	0.724747
0.4	0.133333	3.266667	0.04898	0.191131	0.437186	0.2	0.721274542	5.048922	0.854608
0.5	0.166667	3.333333	0.075	0.152905	0.391031	0.2	0.80627391	5.643917	0.972941
0.6	0.2	3.4	0.105882	0.127421	0.356961	0.2	0.883080336	6.181562	1.08308
0.7	0.233333	3.466667	0.141346	0.109218	0.330481	0.2	0.953675403	6.675728	1.187009
0.8	0.266667	3.533333	0.181132	0.095566	0.309137	0.2	1.01935044	7.135453	1.286017
0.2	0.066667	3.133333	0.012766	0.382263	0.618274	0.24	0.5752773	4.026941	0.641944
0.3	0.1	3.2	0.028125	0.254842	0.504819	0.24	0.70444713	4.93113	0.804447
0.4	0.133333	3.266667	0.04898	0.191131	0.437186	0.24	0.813286001	5.693002	0.946619
0.5	0.166667	3.333333	0.075	0.152905	0.391031	0.24	0.909125449	6.363878	1.075792
0.6	0.2	3.4	0.105882	0.127421	0.356961	0.24	0.995726206	6.970083	1.195726
0.7	0.233333	3.466667	0.141346	0.109218	0.330481	0.24	1.075322711	7.527259	1.308656
0.8	0.266667	3.533333	0.181132	0.095566	0.309137	0.24	1.149371079	8.045598	1.416038
0.2	0.057143	3.614286	0.011067	0.445973	0.667812	0.08	0.299441952	2.096094	0.356585
0.3	0.085714	3.671429	0.024514	0.297316	0.545267	0.08	0.366664079	2.566649	0.452378
0.4	0.114286	3.728571	0.042912	0.222987	0.472215	0.08	0.423299548	2.963097	0.537585
0.5	0.142857	3.785714	0.066038	0.178389	0.422362	0.08	0.473165275	3.312157	0.616022
0.6	0.171429	3.842857	0.09368	0.148658	0.385562	0.08	0.518219226	3.627535	0.689648
0.7	0.2	3.9	0.125641	0.127421	0.356961	0.08	0.559624774	3.917373	0.759625
0.8	0.228571	3.957143	0.161733	0.111493	0.333906	0.08	0.598140077	4.186981	0.826712
0.2	0.057143	3.614286	0.011067	0.445973	0.667812	0.12	0.357707267	2.503951	0.41485
0.3	0.085714	3.671429	0.024514	0.297316	0.545267	0.12	0.438029109	3.066204	0.523743
0.4	0.114286	3.728571	0.042912	0.222987	0.472215	0.12	0.505710428	3.539973	0.619996
0.5	0.142857	3.785714	0.066038	0.178389	0.422362	0.12	0.565309746	3.957168	0.708167
0.6	0.171429	3.842857	0.09368	0.148658	0.385562	0.12	0.619165345	4.334157	0.790594

PRILOG BROJ 1

Tip riblje staze:		normalna naizmjenična rebra
M	N	
0.077	18	

Q (m ³ /s)	v (m/s)	b (m)	pret. Δh	pretp. L
0.35	0.5	3.5	3	25
0.4	0.5	3.5	3	25
0.1	0.5	3.5	4	25
0.15	0.5	3.5	4	25
0.2	0.5	3.5	4	25
0.25	0.5	3.5	4	25
0.3	0.5	3.5	4	25
0.35	0.5	3.5	4	25
0.4	0.5	3.5	4	25
0.1	0.5	3.5	5	25
0.15	0.5	3.5	5	25
0.2	0.5	3.5	5	25
0.25	0.5	3.5	5	25
0.3	0.5	3.5	5	25
0.35	0.5	3.5	5	25
0.4	0.5	3.5	5	25
0.1	0.5	3.5	6	25
0.15	0.5	3.5	6	25
0.2	0.5	3.5	6	25
0.25	0.5	3.5	6	25
0.3	0.5	3.5	6	25
0.35	0.5	3.5	6	25
0.4	0.5	3.5	6	25
0.1	0.5	4	2	25
0.15	0.5	4	2	25
0.2	0.5	4	2	25
0.25	0.5	4	2	25
0.3	0.5	4	2	25
0.35	0.5	4	2	25
0.4	0.5	4	2	25
0.1	0.5	4	3	25
0.15	0.5	4	3	25
0.2	0.5	4	3	25
0.25	0.5	4	3	25
0.3	0.5	4	3	25
0.35	0.5	4	3	25
0.4	0.5	4	3	25
0.1	0.5	4	4	25
0.15	0.5	4	4	25

$\omega = \frac{Q}{v}$	$h = \frac{\omega}{b}$	$\chi = b + 2h$	$\frac{\omega^2}{\chi}$	$\Pi_k = \frac{v^2}{gh}$	$\sqrt{\Pi_k}$	$i = \frac{\Delta h}{L}$	$\Delta = \frac{8g \cdot \omega^2 - M + 2i^2}{Q^2 \cdot \chi - N \log i} \cdot h \cdot \frac{\chi}{b} \sqrt{\Pi_k}$	$\delta = 7\Delta$	uk.Dubina
0.7	0.2	3.9	0.125641	0.127421	0.356961	0.12	0.668666506	4.680666	0.868667
0.8	0.228571	3.957143	0.161733	0.111493	0.333906	0.12	0.714718569	5.00303	0.94329
0.2	0.057143	3.614286	0.011067	0.445973	0.667812	0.16	0.414247935	2.899736	0.471391
0.3	0.085714	3.671429	0.024514	0.297316	0.545267	0.16	0.507273347	3.550913	0.592988
0.4	0.114286	3.728571	0.042912	0.222987	0.472215	0.16	0.585662567	4.099638	0.699948
0.5	0.142857	3.785714	0.066038	0.178389	0.422362	0.16	0.654694236	4.58286	0.797551
0.6	0.171429	3.842857	0.09368	0.148658	0.385562	0.16	0.71707598	5.019532	0.888505
0.7	0.2	3.9	0.125641	0.127421	0.356961	0.16	0.774416495	5.420915	0.974416
0.8	0.228571	3.957143	0.161733	0.111493	0.333906	0.16	0.827764095	5.794349	1.056336
0.2	0.057143	3.614286	0.011067	0.445973	0.667812	0.2	0.47177119	3.302398	0.528914
0.3	0.085714	3.671429	0.024514	0.297316	0.545267	0.2	0.577716029	4.044012	0.66343
0.4	0.114286	3.728571	0.042912	0.222987	0.472215	0.2	0.666992803	4.66895	0.781279
0.5	0.142857	3.785714	0.066038	0.178389	0.422362	0.2	0.745613063	5.219291	0.88847
0.6	0.171429	3.842857	0.09368	0.148658	0.385562	0.2	0.81666036	5.716623	0.988089
0.7	0.2	3.9	0.125641	0.127421	0.356961	0.2	0.881966737	6.173767	1.081967
0.8	0.228571	3.957143	0.161733	0.111493	0.333906	0.2	0.942726046	6.599082	1.171297
0.2	0.057143	3.614286	0.011067	0.445973	0.667812	0.24	0.531944546	3.723612	0.589087
0.3	0.085714	3.671429	0.024514	0.297316	0.545267	0.24	0.651400499	4.559803	0.737115
0.4	0.114286	3.728571	0.042912	0.222987	0.472215	0.24	0.752061822	5.264433	0.866348
0.5	0.142857	3.785714	0.066038	0.178389	0.422362	0.24	0.840706929	5.884948	0.983564
0.6	0.171429	3.842857	0.09368	0.148658	0.385562	0.24	0.920812737	6.445689	1.092241
0.7	0.2	3.9	0.125641	0.127421	0.356961	0.24	0.994445007	6.961115	1.194445
0.8	0.228571	3.957143	0.161733	0.111493	0.333906	0.24	1.062949898	7.440649	1.291521
0.2	0.05	4.1	0.009756	0.509684	0.713922	0.08	0.279609449	1.957266	0.329609
0.3	0.075	4.15	0.021687	0.339789	0.582915	0.08	0.342388102	2.396717	0.417388
0.4	0.1	4.2	0.038095	0.254842	0.504819	0.08	0.395283976	2.766988	0.495284
0.5	0.125	4.25	0.058824	0.203874	0.451524	0.08	0.441860702	3.093025	0.566861
0.6	0.15	4.3	0.083721	0.169895	0.412183	0.08	0.483946273	3.387624	0.633946
0.7	0.175	4.35	0.112644	0.145624	0.381607	0.08	0.522626802	3.658388	0.697627
0.8	0.2	4.4	0.145455	0.127421	0.356961	0.08	0.558610084	3.910271	0.75861
0.2	0.05	4.1	0.009756	0.509684	0.713922	0.12	0.334143374	2.339004	0.384143
0.3	0.075	4.15	0.021687	0.339789	0.582915	0.12	0.409182245	2.864276	0.484182
0.4	0.1	4.2	0.038095	0.254842	0.504819	0.12	0.472415826	3.306911	0.572416
0.5	0.125	4.25	0.058824	0.203874	0.451524	0.12	0.528101893	3.696713	0.653102
0.6	0.15	4.3	0.083721	0.169895	0.412183	0.12	0.578424419	4.048971	0.728424
0.7	0.175	4.35	0.112644	0.145624	0.381607	0.12	0.624680971	4.372767	0.799681
0.8	0.2	4.4	0.145455	0.127421	0.356961	0.12	0.667717108	4.67402	0.867717
0.2	0.05	4.1	0.009756	0.509684	0.713922	0.16	0.387008598	2.70906	0.437009
0.3	0.075	4.15	0.021687	0.339789	0.582915	0.16	0.473925666	3.31748	0.548926

PRILOG BROJ 1

Tip riblje staze:		normalna naizmjenična rebra
M	N	
0.077	18	

Q (m ³ /s)	v (m/s)	b (m)	pret. Δh	pretp. L
0.2	0.5	4	4	25
0.25	0.5	4	4	25
0.3	0.5	4	4	25
0.35	0.5	4	4	25
0.4	0.5	4	4	25
0.1	0.5	4	5	25
0.15	0.5	4	5	25
0.2	0.5	4	5	25
0.25	0.5	4	5	25
0.3	0.5	4	5	25
0.35	0.5	4	5	25
0.4	0.5	4	5	25
0.1	0.5	4	6	25
0.15	0.5	4	6	25
0.2	0.5	4	6	25
0.25	0.5	4	6	25
0.3	0.5	4	6	25
0.35	0.5	4	6	25
0.4	0.5	4	6	25

$\omega = \frac{Q}{v}$	$h = \frac{\omega}{b}$	$\chi = b + 2h$	$\frac{\omega^2}{\chi}$	$\Pi_k = \frac{v^2}{gh}$	$\sqrt{\Pi_k}$	$i = \frac{\Delta h}{L}$	$\Delta = \frac{8g \cdot \frac{\omega^2}{\chi} - \frac{M + 2i^2}{-N \log i}}{h \cdot \frac{\chi}{b} \cdot \sqrt{\Pi_k}}$	$\delta = 7\Delta$	uk. Dubina
0.4	0.1	4.2	0.038095	0.254842	0.504819	0.16	0.547171635	3.830201	0.647172
0.5	0.125	4.25	0.058824	0.203874	0.451524	0.16	0.611677567	4.281743	0.736678
0.6	0.15	4.3	0.083721	0.169895	0.412183	0.16	0.669972752	4.689809	0.819973
0.7	0.175	4.35	0.112644	0.145624	0.381607	0.16	0.723559902	5.064919	0.89856
0.8	0.2	4.4	0.145455	0.127421	0.356961	0.16	0.773418247	5.413928	0.973418
0.2	0.05	4.1	0.009756	0.509684	0.713922	0.2	0.440760648	3.085325	0.490761
0.3	0.075	4.15	0.021687	0.339789	0.582915	0.2	0.53975115	3.778258	0.614751
0.4	0.1	4.2	0.038095	0.254842	0.504819	0.2	0.6231722	4.362205	0.723172
0.5	0.125	4.25	0.058824	0.203874	0.451524	0.2	0.696639662	4.876478	0.82164
0.6	0.15	4.3	0.083721	0.169895	0.412183	0.2	0.763034075	5.341239	0.913034
0.7	0.175	4.35	0.112644	0.145624	0.381607	0.2	0.824066829	5.768468	0.999067
0.8	0.2	4.4	0.145455	0.127421	0.356961	0.2	0.880853137	6.165972	1.080853
0.2	0.05	4.1	0.009756	0.509684	0.713922	0.24	0.496966264	3.478764	0.546966
0.3	0.075	4.15	0.021687	0.339789	0.582915	0.24	0.608578426	4.260049	0.683578
0.4	0.1	4.2	0.038095	0.254842	0.504819	0.24	0.702635242	4.918447	0.802635
0.5	0.125	4.25	0.058824	0.203874	0.451524	0.24	0.785468794	5.498282	0.910469
0.6	0.15	4.3	0.083721	0.169895	0.412183	0.24	0.860326999	6.022289	1.010327
0.7	0.175	4.35	0.112644	0.145624	0.381607	0.24	0.92913952	6.503977	1.10414
0.8	0.2	4.4	0.145455	0.127421	0.356961	0.24	0.993163809	6.952147	1.193164

PRILOG BROJ 1

Tip riblje staze:		normalna naizmjenična rebra
M	N	
0.077	18	

Q (m ³ /s)	v (m/s)	b (m)	pret. Δh	pretp. L
0.1	0.7	2	2	35
0.15	0.7	2	2	35
0.2	0.7	2	2	35
0.25	0.7	2	2	35
0.3	0.7	2	2	35
0.35	0.7	2	2	35
0.4	0.7	2	2	35
0.1	0.7	2	3	35
0.15	0.7	2	3	35
0.2	0.7	2	3	35
0.25	0.7	2	3	35
0.3	0.7	2	3	35
0.35	0.7	2	3	35
0.4	0.7	2	3	35
0.1	0.7	2	4	35
0.15	0.7	2	4	35
0.2	0.7	2	4	35
0.25	0.7	2	4	35
0.3	0.7	2	4	35
0.35	0.7	2	4	35
0.4	0.7	2	4	35
0.1	0.7	2	5	35
0.15	0.7	2	5	35
0.2	0.7	2	5	35
0.25	0.7	2	5	35
0.3	0.7	2	5	35
0.35	0.7	2	5	35
0.4	0.7	2	5	35
0.1	0.7	2	6	35
0.15	0.7	2	6	35
0.2	0.7	2	6	35
0.25	0.7	2	6	35
0.3	0.7	2	6	35
0.35	0.7	2	6	35
0.4	0.7	2	6	35
0.1	0.7	2.5	2	35
0.15	0.7	2.5	2	35
0.2	0.7	2.5	2	35
0.25	0.7	2.5	2	35

$\omega = \frac{Q}{v}$	$h = \frac{\omega}{b}$	$\chi = b + 2h$	$\frac{\omega^2}{\chi}$	$\Pi_k = \frac{v^2}{gh}$	$\sqrt{\Pi_k}$	$i = \frac{\Delta h}{L}$	$\Delta = \frac{8g \cdot \omega^2 - M + 2i^2}{Q^2 \cdot \chi - N \log i} \cdot h \cdot \frac{\chi}{b} \cdot \sqrt{\Pi_k}$	$\delta = 7\Delta$	uk.Dubina
0.142857	0.071429	2.142857	0.009524	0.699286	0.836233	0.057143	0.209603063	1.467221	0.281032
0.214286	0.107143	2.214286	0.020737	0.466191	0.682782	0.057143	0.256539584	1.795777	0.363682
0.285714	0.142857	2.285714	0.035714	0.349643	0.591306	0.057143	0.296029297	2.072205	0.438886
0.357143	0.178571	2.357143	0.054113	0.279715	0.52888	0.057143	0.330750453	2.315253	0.509322
0.428571	0.214286	2.428571	0.07563	0.233095	0.4828	0.057143	0.362077573	2.534543	0.576363
0.5	0.25	2.5	0.1	0.199796	0.446986	0.057143	0.390827741	2.735794	0.640828
0.571429	0.285714	2.571429	0.126984	0.174822	0.418117	0.057143	0.41753369	2.922736	0.703248
0.142857	0.071429	2.142857	0.009524	0.699286	0.836233	0.085714	0.245502767	1.718519	0.316931
0.214286	0.107143	2.214286	0.020737	0.466191	0.682782	0.085714	0.300532723	2.103729	0.407676
0.285714	0.142857	2.285714	0.035714	0.349643	0.591306	0.085714	0.346857251	2.428001	0.489714
0.357143	0.178571	2.357143	0.054113	0.279715	0.52888	0.085714	0.387610315	2.713272	0.566182
0.428571	0.214286	2.428571	0.07563	0.233095	0.4828	0.085714	0.424400012	2.9708	0.638686
0.5	0.25	2.5	0.1	0.199796	0.446986	0.085714	0.458182101	3.207275	0.708182
0.571429	0.285714	2.571429	0.126984	0.174822	0.418117	0.085714	0.489579617	3.427057	0.775294
0.142857	0.071429	2.142857	0.009524	0.699286	0.836233	0.114286	0.278695823	1.950871	0.350124
0.214286	0.107143	2.214286	0.020737	0.466191	0.682782	0.114286	0.341192246	2.388346	0.448335
0.285714	0.142857	2.285714	0.035714	0.349643	0.591306	0.114286	0.393814328	2.7567	0.536671
0.357143	0.178571	2.357143	0.054113	0.279715	0.52888	0.114286	0.440118311	3.080828	0.61869
0.428571	0.214286	2.428571	0.07563	0.233095	0.4828	0.114286	0.48192883	3.373502	0.696215
0.5	0.25	2.5	0.1	0.199796	0.446986	0.114286	0.520330253	3.642312	0.77033
0.571429	0.285714	2.571429	0.126984	0.174822	0.418117	0.114286	0.556029396	3.892206	0.841744
0.142857	0.071429	2.142857	0.009524	0.699286	0.836233	0.142857	0.310981239	2.176869	0.38241
0.214286	0.107143	2.214286	0.020737	0.466191	0.682782	0.142857	0.380731029	2.665117	0.487874
0.285714	0.142857	2.285714	0.035714	0.349643	0.591306	0.142857	0.439466763	3.076267	0.582324
0.357143	0.178571	2.357143	0.054113	0.279715	0.52888	0.142857	0.491155911	3.438091	0.669727
0.428571	0.214286	2.428571	0.07563	0.233095	0.4828	0.142857	0.537834023	3.764838	0.75212
0.5	0.25	2.5	0.1	0.199796	0.446986	0.142857	0.580710769	4.064975	0.830711
0.571429	0.285714	2.571429	0.126984	0.174822	0.418117	0.142857	0.620574614	4.344022	0.906289
0.142857	0.071429	2.142857	0.009524	0.699286	0.836233	0.171429	0.343282541	2.402978	0.414711
0.214286	0.107143	2.214286	0.020737	0.466191	0.682782	0.171429	0.420283435	2.941984	0.527426
0.285714	0.142857	2.285714	0.035714	0.349643	0.591306	0.171429	0.485128192	3.395897	0.627985
0.357143	0.178571	2.357143	0.054113	0.279715	0.52888	0.171429	0.542196034	3.795372	0.720767
0.428571	0.214286	2.428571	0.07563	0.233095	0.4828	0.171429	0.593733728	4.156136	0.808019
0.5	0.25	2.5	0.1	0.199796	0.446986	0.171429	0.641076446	4.487535	0.891076
0.571429	0.285714	2.571429	0.126984	0.174822	0.418117	0.171429	0.685094441	4.795661	0.970809
0.142857	0.057143	2.614286	0.007806	0.874108	0.934937	0.057143	0.186651949	1.306564	0.243795
0.214286	0.085714	2.671429	0.017189	0.582739	0.763373	0.057143	0.22847888	1.599352	0.314193
0.285714	0.114286	2.728571	0.029918	0.437054	0.661101	0.057143	0.263683653	1.845786	0.377969
0.357143	0.142857	2.785714	0.045788	0.349643	0.591306	0.057143	0.294649608	2.062547	0.437507

PRILOG BROJ 1

Tip riblje staze:		normalna naizmjenična rebra
M	N	
0.077	18	

Q (m ³ /s)	v (m/s)	b (m)	pret. Δh	pretp. L
0.3	0.7	2.5	2	35
0.35	0.7	2.5	2	35
0.4	0.7	2.5	2	35
0.1	0.7	2.5	3	35
0.15	0.7	2.5	3	35
0.2	0.7	2.5	3	35
0.25	0.7	2.5	3	35
0.3	0.7	2.5	3	35
0.35	0.7	2.5	3	35
0.4	0.7	2.5	3	35
0.1	0.7	2.5	4	35
0.15	0.7	2.5	4	35
0.2	0.7	2.5	4	35
0.25	0.7	2.5	4	35
0.3	0.7	2.5	4	35
0.35	0.7	2.5	4	35
0.4	0.7	2.5	4	35
0.1	0.7	2.5	5	35
0.15	0.7	2.5	5	35
0.2	0.7	2.5	5	35
0.25	0.7	2.5	5	35
0.3	0.7	2.5	5	35
0.35	0.7	2.5	5	35
0.4	0.7	2.5	5	35
0.1	0.7	2.5	6	35
0.15	0.7	2.5	6	35
0.2	0.7	2.5	6	35
0.25	0.7	2.5	6	35
0.3	0.7	2.5	6	35
0.35	0.7	2.5	6	35
0.4	0.7	2.5	6	35
0.1	0.7	3	2	35
0.15	0.7	3	2	35
0.2	0.7	3	2	35
0.25	0.7	3	2	35
0.3	0.7	3	2	35
0.35	0.7	3	2	35
0.4	0.7	3	2	35
0.1	0.7	3	3	35

$\omega = \frac{Q}{v}$	$h = \frac{\omega}{b}$	$\chi = b + 2h$	$\frac{\omega^2}{\chi}$	$\Pi_k = \frac{v^2}{gh}$	$\sqrt{\Pi_k}$	$i = \frac{\Delta h}{L}$	$\Delta = \frac{8g \cdot \omega^2 - M + 2i^2}{Q^2 \cdot \chi - N \log i} \cdot h \cdot \frac{\chi}{b} \cdot \sqrt{\Pi_k}$	$\delta = 7\Delta$	uk.Dubina
0.428571	0.171429	2.842857	0.064609	0.291369	0.539786	0.057143	0.322599745	2.258198	0.494028
0.5	0.2	2.9	0.086207	0.249745	0.499745	0.057143	0.348260982	2.437827	0.548261
0.571429	0.228571	2.957143	0.110421	0.218527	0.467469	0.057143	0.3721072	2.60475	0.600679
0.142857	0.057143	2.614286	0.007806	0.874108	0.934937	0.085714	0.218882892	1.53218	0.276026
0.214286	0.085714	2.671429	0.017189	0.582739	0.763373	0.085714	0.267971565	1.875801	0.353686
0.285714	0.114286	2.728571	0.029918	0.437054	0.661101	0.085714	0.309306666	2.165147	0.423592
0.357143	0.142857	2.785714	0.045788	0.349643	0.591306	0.085714	0.345680929	2.419767	0.488538
0.428571	0.171429	2.842857	0.064609	0.291369	0.539786	0.085714	0.378527217	2.649691	0.549956
0.5	0.2	2.9	0.086207	0.249745	0.499745	0.085714	0.408697055	2.860879	0.608697
0.571429	0.228571	2.957143	0.110421	0.218527	0.467469	0.085714	0.436745479	3.057218	0.665317
0.142857	0.057143	2.614286	0.007806	0.874108	0.934937	0.114286	0.248602984	1.740221	0.305746
0.214286	0.085714	2.671429	0.017189	0.582739	0.763373	0.114286	0.304375745	2.13063	0.39009
0.285714	0.114286	2.728571	0.029918	0.437054	0.661101	0.114286	0.351347961	2.459436	0.465634
0.357143	0.142857	2.785714	0.045788	0.349643	0.591306	0.114286	0.392690528	2.748834	0.535548
0.428571	0.171429	2.842857	0.064609	0.291369	0.539786	0.114286	0.430030229	3.010212	0.601459
0.5	0.2	2.9	0.086207	0.249745	0.499745	0.114286	0.464333769	3.250336	0.664334
0.571429	0.228571	2.957143	0.110421	0.218527	0.467469	0.114286	0.496231221	3.473619	0.724803
0.142857	0.057143	2.614286	0.007806	0.874108	0.934937	0.142857	0.277467337	1.942271	0.33461
0.214286	0.085714	2.671429	0.017189	0.582739	0.763373	0.142857	0.339725343	2.378077	0.42544
0.285714	0.114286	2.728571	0.029918	0.437054	0.661101	0.142857	0.392164002	2.745148	0.50645
0.357143	0.142857	2.785714	0.045788	0.349643	0.591306	0.142857	0.438321834	3.068253	0.581179
0.428571	0.171429	2.842857	0.064609	0.291369	0.539786	0.142857	0.480014174	3.360099	0.651443
0.5	0.2	2.9	0.086207	0.249745	0.499745	0.142857	0.518319743	3.628238	0.71832
0.571429	0.228571	2.957143	0.110421	0.218527	0.467469	0.142857	0.553941601	3.877591	0.782513
0.142857	0.057143	2.614286	0.007806	0.874108	0.934937	0.171429	0.306317779	2.144224	0.363461
0.214286	0.085714	2.671429	0.017189	0.582739	0.763373	0.171429	0.375053729	2.625376	0.460768
0.285714	0.114286	2.728571	0.029918	0.437054	0.661101	0.171429	0.432950727	3.030655	0.547236
0.357143	0.142857	2.785714	0.045788	0.349643	0.591306	0.171429	0.483914975	3.387405	0.626772
0.428571	0.171429	2.842857	0.064609	0.291369	0.539786	0.171429	0.529950408	3.709653	0.701379
0.5	0.2	2.9	0.086207	0.249745	0.499745	0.171429	0.572247806	4.005735	0.772248
0.571429	0.228571	2.957143	0.110421	0.218527	0.467469	0.171429	0.611583253	4.281083	0.840155
0.142857	0.047619	3.095238	0.006593	1.04893	1.024173	0.057143	0.16962292	1.18736	0.217242
0.214286	0.071429	3.142857	0.01461	0.699286	0.836233	0.057143	0.207651888	1.453563	0.27908
0.285714	0.095238	3.190476	0.025586	0.524465	0.724199	0.057143	0.23966846	1.677679	0.334907
0.357143	0.119048	3.238095	0.039391	0.419572	0.647744	0.057143	0.267837534	1.874863	0.386885
0.428571	0.142857	3.285714	0.055901	0.349643	0.591306	0.057143	0.293269919	2.052889	0.436127
0.5	0.166667	3.333333	0.075	0.299694	0.547443	0.057143	0.316625789	2.216381	0.483292
0.571429	0.190476	3.380952	0.096579	0.262232	0.512086	0.057143	0.33833548	2.368348	0.528812
0.142857	0.047619	3.095238	0.006593	1.04893	1.024173	0.085714	0.199158551	1.39411	0.246778

PRILOG BROJ 1

Tip riblje staze:		normalna naizmjenična rebra
M	N	
0.077	18	

Q (m ³ /s)	v (m/s)	b (m)	pret. Δh	pretp. L
0.15	0.7	3	3	35
0.2	0.7	3	3	35
0.25	0.7	3	3	35
0.3	0.7	3	3	35
0.35	0.7	3	3	35
0.4	0.7	3	3	35
0.1	0.7	3	4	35
0.15	0.7	3	4	35
0.2	0.7	3	4	35
0.25	0.7	3	4	35
0.3	0.7	3	4	35
0.35	0.7	3	4	35
0.4	0.7	3	4	35
0.1	0.7	3	5	35
0.15	0.7	3	5	35
0.2	0.7	3	5	35
0.25	0.7	3	5	35
0.3	0.7	3	5	35
0.35	0.7	3	5	35
0.4	0.7	3	5	35
0.1	0.7	3	6	35
0.15	0.7	3	6	35
0.2	0.7	3	6	35
0.25	0.7	3	6	35
0.3	0.7	3	6	35
0.35	0.7	3	6	35
0.4	0.7	3	6	35
0.1	0.7	3.5	2	35
0.15	0.7	3.5	2	35
0.2	0.7	3.5	2	35
0.25	0.7	3.5	2	35
0.3	0.7	3.5	2	35
0.35	0.7	3.5	2	35
0.4	0.7	3.5	2	35
0.1	0.7	3.5	3	35
0.15	0.7	3.5	3	35
0.2	0.7	3.5	3	35
0.25	0.7	3.5	3	35
0.3	0.7	3.5	3	35

$\omega = \frac{Q}{v}$	$h = \frac{\omega}{b}$	$\chi = b + 2h$	$\frac{\omega^2}{\chi}$	$\Pi_k = \frac{v^2}{gh}$	$\sqrt{\Pi_k}$	$i = \frac{\Delta h}{L}$	$\Delta = \frac{8g \cdot \omega^2 - M + 2i^2}{Q^2 \cdot \chi - N \log i} \cdot h \cdot \frac{\chi}{b} \cdot \sqrt{\Pi_k}$	$\delta = 7\Delta$	uk.Dubina
0.214286	0.071429	3.142857	0.01461	0.699286	0.836233	0.085714	0.243839196	1.706874	0.315268
0.285714	0.095238	3.190476	0.025586	0.524465	0.724199	0.085714	0.281469779	1.970288	0.376708
0.357143	0.119048	3.238095	0.039391	0.419572	0.647744	0.085714	0.31459051	2.202134	0.433638
0.428571	0.142857	3.285714	0.055901	0.349643	0.591306	0.085714	0.344504606	2.411532	0.487362
0.5	0.166667	3.333333	0.075	0.299694	0.547443	0.085714	0.371986497	2.603905	0.538653
0.571429	0.190476	3.380952	0.096579	0.262232	0.512086	0.085714	0.39754093	2.782787	0.588017
0.142857	0.047619	3.095238	0.006593	1.04893	1.024173	0.114286	0.226318328	1.584228	0.273937
0.214286	0.071429	3.142857	0.01461	0.699286	0.836233	0.114286	0.277106531	1.939746	0.348535
0.285714	0.095238	3.190476	0.025586	0.524465	0.724199	0.114286	0.319887673	2.239214	0.415126
0.357143	0.119048	3.238095	0.039391	0.419572	0.647744	0.114286	0.357547587	2.502833	0.476595
0.428571	0.142857	3.285714	0.055901	0.349643	0.591306	0.114286	0.391566729	2.740967	0.534424
0.5	0.166667	3.333333	0.075	0.299694	0.547443	0.114286	0.422824803	2.959774	0.589491
0.571429	0.190476	3.380952	0.096579	0.262232	0.512086	0.114286	0.451895142	3.163266	0.642371
0.142857	0.047619	3.095238	0.006593	1.04893	1.024173	0.142857	0.252656023	1.768592	0.300275
0.214286	0.071429	3.142857	0.01461	0.699286	0.836233	0.142857	0.309362065	2.165534	0.380791
0.285714	0.095238	3.190476	0.025586	0.524465	0.724199	0.142857	0.357131512	2.499921	0.45237
0.357143	0.119048	3.238095	0.039391	0.419572	0.647744	0.142857	0.399185628	2.794299	0.518233
0.428571	0.142857	3.285714	0.055901	0.349643	0.591306	0.142857	0.437176906	3.060238	0.580034
0.5	0.166667	3.333333	0.075	0.299694	0.547443	0.142857	0.47208725	3.304611	0.638754
0.571429	0.190476	3.380952	0.096579	0.262232	0.512086	0.142857	0.504556589	3.531896	0.695033
0.142857	0.047619	3.095238	0.006593	1.04893	1.024173	0.171429	0.278954828	1.952684	0.326574
0.214286	0.071429	3.142857	0.01461	0.699286	0.836233	0.171429	0.341566793	2.390968	0.412995
0.285714	0.095238	3.190476	0.025586	0.524465	0.724199	0.171429	0.394313018	2.760191	0.489551
0.357143	0.119048	3.238095	0.039391	0.419572	0.647744	0.171429	0.440749879	3.085249	0.559797
0.428571	0.142857	3.285714	0.055901	0.349643	0.591306	0.171429	0.482701757	3.378912	0.625559
0.5	0.166667	3.333333	0.075	0.299694	0.547443	0.171429	0.521252685	3.648769	0.687919
0.571429	0.190476	3.380952	0.096579	0.262232	0.512086	0.171429	0.55710914	3.899764	0.747585
0.142857	0.040816	3.581633	0.005698	1.223751	1.106233	0.057143	0.156322901	1.09426	0.197139
0.214286	0.061224	3.622449	0.012676	0.815834	0.903235	0.057143	0.191381939	1.339674	0.252606
0.285714	0.081633	3.663265	0.022284	0.611876	0.782225	0.057143	0.220903689	1.546326	0.302536
0.357143	0.102041	3.704082	0.034435	0.489501	0.699643	0.057143	0.246882645	1.728179	0.348923
0.428571	0.122449	3.744898	0.049046	0.407917	0.638684	0.057143	0.270342114	1.892395	0.392791
0.5	0.142857	3.785714	0.066038	0.349643	0.591306	0.057143	0.291890229	2.043232	0.434747
0.571429	0.163265	3.826531	0.085333	0.305938	0.553116	0.057143	0.311923377	2.183464	0.475189
0.142857	0.040816	3.581633	0.005698	1.223751	1.106233	0.085714	0.183773328	1.286413	0.22459
0.214286	0.061224	3.622449	0.012676	0.815834	0.903235	0.085714	0.225012577	1.575088	0.286237
0.285714	0.081633	3.663265	0.022284	0.611876	0.782225	0.085714	0.259749555	1.818247	0.341382
0.357143	0.102041	3.704082	0.034435	0.489501	0.699643	0.085714	0.290327674	2.032294	0.392368
0.428571	0.122449	3.744898	0.049046	0.407917	0.638684	0.085714	0.317949129	2.225644	0.440398

Tip riblje staze:		normalna naizmjenična rebra
M	N	
0.077	18	

Q (m ³ /s)	v (m/s)	b (m)	pret. Δh	pretp. L
0.35	0.7	3.5	3	35
0.4	0.7	3.5	3	35
0.1	0.7	3.5	4	35
0.15	0.7	3.5	4	35
0.2	0.7	3.5	4	35
0.25	0.7	3.5	4	35
0.3	0.7	3.5	4	35
0.35	0.7	3.5	4	35
0.4	0.7	3.5	4	35
0.1	0.7	3.5	5	35
0.15	0.7	3.5	5	35
0.2	0.7	3.5	5	35
0.25	0.7	3.5	5	35
0.3	0.7	3.5	5	35
0.35	0.7	3.5	5	35
0.4	0.7	3.5	5	35
0.1	0.7	3.5	6	35
0.15	0.7	3.5	6	35
0.2	0.7	3.5	6	35
0.25	0.7	3.5	6	35
0.3	0.7	3.5	6	35
0.35	0.7	3.5	6	35
0.4	0.7	3.5	6	35
0.1	0.7	4	2	35
0.15	0.7	4	2	35
0.2	0.7	4	2	35
0.25	0.7	4	2	35
0.3	0.7	4	2	35
0.35	0.7	4	2	35
0.4	0.7	4	2	35
0.1	0.7	4	3	35
0.15	0.7	4	3	35
0.2	0.7	4	3	35
0.25	0.7	4	3	35
0.3	0.7	4	3	35
0.35	0.7	4	3	35
0.4	0.7	4	3	35
0.1	0.7	4	4	35
0.15	0.7	4	4	35

$\omega = \frac{Q}{v}$	$h = \frac{\omega}{b}$	$\chi = b + 2h$	$\frac{\omega^2}{\chi}$	$\Pi_k = \frac{v^2}{gh}$	$\sqrt{\Pi_k}$	$i = \frac{\Delta h}{L}$	$\Delta = \frac{8g \cdot \omega^2 - M + 2i^2}{Q^2 \cdot \chi - N \log i} \cdot h \cdot \frac{\chi}{b} \cdot \sqrt{\Pi_k}$	$\delta = 7\Delta$	uk.Dubina
0.5	0.142857	3.785714	0.066038	0.349643	0.591306	0.085714	0.343328284	2.403298	0.486185
0.571429	0.163265	3.826531	0.085333	0.305938	0.553116	0.085714	0.366930718	2.568515	0.530196
0.142857	0.040816	3.581633	0.005698	1.223751	1.106233	0.114286	0.208945707	1.46262	0.249762
0.214286	0.061224	3.622449	0.012676	0.815834	0.903235	0.114286	0.255845126	1.790916	0.31707
0.285714	0.081633	3.663265	0.022284	0.611876	0.782225	0.114286	0.295355157	2.067486	0.376988
0.357143	0.102041	3.704082	0.034435	0.489501	0.699643	0.114286	0.33013957	2.310977	0.43218
0.428571	0.122449	3.744898	0.049046	0.407917	0.638684	0.114286	0.361564846	2.530954	0.484014
0.5	0.142857	3.785714	0.066038	0.349643	0.591306	0.114286	0.39044293	2.733101	0.5333
0.571429	0.163265	3.826531	0.085333	0.305938	0.553116	0.114286	0.417302977	2.921121	0.580568
0.142857	0.040816	3.581633	0.005698	1.223751	1.106233	0.142857	0.233318687	1.633231	0.274135
0.214286	0.061224	3.622449	0.012676	0.815834	0.903235	0.142857	0.285694679	1.999863	0.346919
0.285714	0.081633	3.663265	0.022284	0.611876	0.782225	0.142857	0.329821148	2.308748	0.411454
0.357143	0.102041	3.704082	0.034435	0.489501	0.699643	0.142857	0.368672263	2.580706	0.470713
0.428571	0.122449	3.744898	0.049046	0.407917	0.638684	0.142857	0.403773699	2.826416	0.526223
0.5	0.142857	3.785714	0.066038	0.349643	0.591306	0.142857	0.436031977	3.052224	0.578889
0.571429	0.163265	3.826531	0.085333	0.305938	0.553116	0.142857	0.466037874	3.262265	0.629303
0.142857	0.040816	3.581633	0.005698	1.223751	1.106233	0.171429	0.257631141	1.803418	0.298447
0.214286	0.061224	3.622449	0.012676	0.815834	0.903235	0.171429	0.315467583	2.208273	0.376692
0.285714	0.081633	3.663265	0.022284	0.611876	0.782225	0.171429	0.364195722	2.54937	0.445828
0.357143	0.102041	3.704082	0.034435	0.489501	0.699643	0.171429	0.407099493	2.849696	0.50914
0.428571	0.122449	3.744898	0.049046	0.407917	0.638684	0.171429	0.44586346	3.121044	0.568312
0.5	0.142857	3.785714	0.066038	0.349643	0.591306	0.171429	0.48148854	3.37042	0.624346
0.571429	0.163265	3.826531	0.085333	0.305938	0.553116	0.171429	0.514627024	3.602389	0.677892
0.142857	0.035714	4.071429	0.005013	1.398573	1.182613	0.057143	0.145550918	1.018856	0.181265
0.214286	0.053571	4.107143	0.01118	0.932382	0.965599	0.057143	0.178202391	1.247417	0.231774
0.285714	0.071429	4.142857	0.019704	0.699286	0.836233	0.057143	0.205700712	1.439905	0.277129
0.357143	0.089286	4.178571	0.030525	0.559429	0.74795	0.057143	0.229902478	1.609317	0.319188
0.428571	0.107143	4.214286	0.043584	0.466191	0.682782	0.057143	0.2517602	1.762321	0.358903
0.5	0.125	4.25	0.058824	0.399592	0.632133	0.057143	0.271839911	1.902879	0.39684
0.571429	0.142857	4.285714	0.07619	0.349643	0.591306	0.057143	0.29051054	2.033574	0.433368
0.142857	0.035714	4.071429	0.005013	1.398573	1.182613	0.085714	0.17132805	1.199296	0.207042
0.214286	0.053571	4.107143	0.01118	0.932382	0.965599	0.085714	0.209781697	1.468472	0.263353
0.285714	0.071429	4.142857	0.019704	0.699286	0.836233	0.085714	0.242175625	1.695229	0.313604
0.357143	0.089286	4.178571	0.030525	0.559429	0.74795	0.085714	0.270694154	1.894859	0.35998
0.428571	0.107143	4.214286	0.043584	0.466191	0.682782	0.085714	0.296457823	2.075205	0.403601
0.5	0.125	4.25	0.058824	0.399592	0.632133	0.085714	0.32013245	2.240927	0.445132
0.571429	0.142857	4.285714	0.07619	0.349643	0.591306	0.085714	0.342151961	2.395064	0.485009
0.142857	0.035714	4.071429	0.005013	1.398573	1.182613	0.114286	0.19490038	1.364303	0.230615
0.214286	0.053571	4.107143	0.01118	0.932382	0.965599	0.114286	0.238654084	1.670579	0.292226

PRILOG BROJ 1

Tip riblje staze:		normalna naizmjenična rebra
M	N	
0.077	18	

Q (m ³ /s)	v (m/s)	b (m)	pret. Δh	pretp. L
0.2	0.7	4	4	35
0.25	0.7	4	4	35
0.3	0.7	4	4	35
0.35	0.7	4	4	35
0.4	0.7	4	4	35
0.1	0.7	4	5	35
0.15	0.7	4	5	35
0.2	0.7	4	5	35
0.25	0.7	4	5	35
0.3	0.7	4	5	35
0.35	0.7	4	5	35
0.4	0.7	4	5	35
0.1	0.7	4	6	35
0.15	0.7	4	6	35
0.2	0.7	4	6	35
0.25	0.7	4	6	35
0.3	0.7	4	6	35
0.35	0.7	4	6	35
0.4	0.7	4	6	35

$\omega = \frac{Q}{v}$	$h = \frac{\omega}{b}$	$\chi = b + 2h$	$\frac{\omega^2}{\chi}$	$\Pi_k = \frac{v^2}{gh}$	$\sqrt{\Pi_k}$	$i = \frac{\Delta h}{L}$	$\Delta = \frac{8g \cdot \omega^2 - M + 2i^2}{Q^2 \cdot \chi - N \log i} \cdot h \cdot \frac{\chi}{b} \cdot \sqrt{\Pi_k}$	$\delta = 7\Delta$	uk. Dubina
0.285714	0.071429	4.142857	0.019704	0.699286	0.836233	0.114286	0.275517239	1.928621	0.346946
0.357143	0.089286	4.178571	0.030525	0.559429	0.74795	0.114286	0.307974178	2.155819	0.39726
0.428571	0.107143	4.214286	0.043584	0.466191	0.682782	0.114286	0.337299292	2.361095	0.444442
0.5	0.125	4.25	0.058824	0.399592	0.632133	0.114286	0.364249788	2.549749	0.48925
0.571429	0.142857	4.285714	0.07619	0.349643	0.591306	0.114286	0.389319131	2.725234	0.532176
0.142857	0.035714	4.071429	0.005013	1.398573	1.182613	0.142857	0.217688866	1.523822	0.253403
0.214286	0.053571	4.107143	0.01118	0.932382	0.965599	0.142857	0.266563242	1.865943	0.320135
0.285714	0.071429	4.142857	0.019704	0.699286	0.836233	0.142857	0.307742891	2.1542	0.379171
0.357143	0.089286	4.178571	0.030525	0.559429	0.74795	0.142857	0.344002359	2.408017	0.433288
0.428571	0.107143	4.214286	0.043584	0.466191	0.682782	0.142857	0.37676488	2.637354	0.483908
0.5	0.125	4.25	0.058824	0.399592	0.632133	0.142857	0.406876083	2.848133	0.531876
0.571429	0.142857	4.285714	0.07619	0.349643	0.591306	0.142857	0.434887048	3.044209	0.577744
0.142857	0.035714	4.071429	0.005013	1.398573	1.182613	0.171429	0.240397636	1.682783	0.276112
0.214286	0.053571	4.107143	0.01118	0.932382	0.965599	0.171429	0.294372705	2.060609	0.347944
0.285714	0.071429	4.142857	0.019704	0.699286	0.836233	0.171429	0.339851044	2.378957	0.41128
0.357143	0.089286	4.178571	0.030525	0.559429	0.74795	0.171429	0.379896509	2.659276	0.469182
0.428571	0.107143	4.214286	0.043584	0.466191	0.682782	0.171429	0.416080727	2.912565	0.523224
0.5	0.125	4.25	0.058824	0.399592	0.632133	0.171429	0.449337488	3.145362	0.574337
0.571429	0.142857	4.285714	0.07619	0.349643	0.591306	0.171429	0.480275322	3.361927	0.623132

PRILOG BROJ 1

Tip riblje staze:		normalna naizmjenična rebra
M	N	
0.077	18	

Q (m ³ /s)	v (m/s)	b (m)	pret. Δh	pretp. L
0.1	1	2	2	35
0.15	1	2	2	35
0.2	1	2	2	35
0.25	1	2	2	35
0.3	1	2	2	35
0.35	1	2	2	35
0.4	1	2	2	35
0.1	1	2	3	35
0.15	1	2	3	35
0.2	1	2	3	35
0.25	1	2	3	35
0.3	1	2	3	35
0.35	1	2	3	35
0.4	1	2	3	35
0.1	1	2	4	35
0.15	1	2	4	35
0.2	1	2	4	35
0.25	1	2	4	35
0.3	1	2	4	35
0.35	1	2	4	35
0.4	1	2	4	35
0.1	1	2	5	35
0.15	1	2	5	35
0.2	1	2	5	35
0.25	1	2	5	35
0.3	1	2	5	35
0.35	1	2	5	35
0.4	1	2	5	35
0.1	1	2	6	35
0.15	1	2	6	35
0.2	1	2	6	35
0.25	1	2	6	35
0.3	1	2	6	35
0.35	1	2	6	35
0.4	1	2	6	35
0.1	1	2.5	2	35
0.15	1	2.5	2	35
0.2	1	2.5	2	35
0.25	1	2.5	2	35

$\omega = \frac{Q}{v}$	$h = \frac{\omega}{b}$	$\chi = b + 2h$	$\frac{\omega^2}{\chi}$	$\Pi_k = \frac{v^2}{gh}$	$\sqrt{\Pi_k}$	$i = \frac{\Delta h}{L}$	$\Delta = \frac{8g \cdot \omega^2 - M + 2i^2}{Q^2 \cdot \chi - N \log i} \cdot h \cdot \frac{\chi}{b} \cdot \sqrt{\Pi_k}$	$\delta = 7\Delta$	uk.Dubina
0.1	0.05	2.1	0.004762	2.038736	1.427843	0.057143	0.120307847	0.842155	0.170308
0.15	0.075	2.15	0.010465	1.359157	1.165829	0.057143	0.147203608	1.030425	0.222204
0.2	0.1	2.2	0.018182	1.019368	1.009638	0.057143	0.16981118	1.188678	0.269811
0.25	0.125	2.25	0.027778	0.815494	0.903047	0.057143	0.189670303	1.327692	0.31467
0.3	0.15	2.3	0.03913	0.679579	0.824366	0.057143	0.207571441	1.453	0.357571
0.35	0.175	2.35	0.052128	0.582496	0.763214	0.057143	0.223984633	1.567892	0.398985
0.4	0.2	2.4	0.066667	0.509684	0.713922	0.057143	0.239216434	1.674515	0.439216
0.1	0.05	2.1	0.004762	2.038736	1.427843	0.085714	0.141693881	0.991857	0.191694
0.15	0.075	2.15	0.010465	1.359157	1.165829	0.085714	0.173417093	1.21392	0.248417
0.2	0.1	2.2	0.018182	1.019368	1.009638	0.085714	0.200104213	1.400729	0.300104
0.25	0.125	2.25	0.027778	0.815494	0.903047	0.085714	0.223566119	1.564963	0.348566
0.3	0.15	2.3	0.03913	0.679579	0.824366	0.085714	0.244732217	1.713126	0.394732
0.35	0.175	2.35	0.052128	0.582496	0.763214	0.085714	0.264155014	1.849085	0.439155
0.4	0.2	2.4	0.066667	0.509684	0.713922	0.085714	0.282194753	1.975363	0.482195
0.1	0.05	2.1	0.004762	2.038736	1.427843	0.114286	0.161227013	1.128589	0.211227
0.15	0.075	2.15	0.010465	1.359157	1.165829	0.114286	0.197345633	1.381419	0.272346
0.2	0.1	2.2	0.018182	1.019368	1.009638	0.114286	0.227740789	1.594186	0.327741
0.25	0.125	2.25	0.027778	0.815494	0.903047	0.114286	0.254471769	1.781302	0.379472
0.3	0.15	2.3	0.03913	0.679579	0.824366	0.114286	0.278595349	1.950167	0.428595
0.35	0.175	2.35	0.052128	0.582496	0.763214	0.114286	0.300739681	2.105178	0.47574
0.4	0.2	2.4	0.066667	0.509684	0.713922	0.114286	0.321314285	2.2492	0.521314
0.1	0.05	2.1	0.004762	2.038736	1.427843	0.142857	0.180097853	1.260685	0.230098
0.15	0.075	2.15	0.010465	1.359157	1.165829	0.142857	0.220455411	1.543188	0.295455
0.2	0.1	2.2	0.018182	1.019368	1.009638	0.142857	0.254423136	1.780962	0.354423
0.25	0.125	2.25	0.027778	0.815494	0.903047	0.142857	0.284300716	1.990105	0.409301
0.3	0.15	2.3	0.03913	0.679579	0.824366	0.142857	0.31126823	2.178878	0.461268
0.35	0.175	2.35	0.052128	0.582496	0.763214	0.142857	0.336027086	2.35219	0.511027
0.4	0.2	2.4	0.066667	0.509684	0.713922	0.142857	0.359034537	2.513242	0.559035
0.1	0.05	2.1	0.004762	2.038736	1.427843	0.171429	0.198894299	1.39226	0.248894
0.15	0.075	2.15	0.010465	1.359157	1.165829	0.171429	0.243469192	1.704284	0.318469
0.2	0.1	2.2	0.018182	1.019368	1.009638	0.171429	0.280989	1.966923	0.380989
0.25	0.125	2.25	0.027778	0.815494	0.903047	0.171429	0.31399313	2.197952	0.438993
0.3	0.15	2.3	0.03913	0.679579	0.824366	0.171429	0.343784643	2.406493	0.493785
0.35	0.175	2.35	0.052128	0.582496	0.763214	0.171429	0.371138028	2.597966	0.546138
0.4	0.2	2.4	0.066667	0.509684	0.713922	0.171429	0.39655817	2.775907	0.596558
0.1	0.04	2.58	0.003876	2.54842	1.596377	0.057143	0.106605381	0.746238	0.146605
0.15	0.06	2.62	0.008588	1.698947	1.303436	0.057143	0.130462206	0.913235	0.190462
0.2	0.08	2.66	0.015038	1.27421	1.128809	0.057143	0.150526783	1.053687	0.230527
0.25	0.1	2.7	0.023148	1.019368	1.009638	0.057143	0.168162136	1.177135	0.268162

Tip riblje staze:		normalna naizmjenična rebra
M	N	
0.077	18	

Q (m ³ /s)	v (m/s)	b (m)	pret. Δh	pretp. L
0.3	1	2.5	2	35
0.35	1	2.5	2	35
0.4	1	2.5	2	35
0.1	1	2.5	3	35
0.15	1	2.5	3	35
0.2	1	2.5	3	35
0.25	1	2.5	3	35
0.3	1	2.5	3	35
0.35	1	2.5	3	35
0.4	1	2.5	3	35
0.1	1	2.5	4	35
0.15	1	2.5	4	35
0.2	1	2.5	4	35
0.25	1	2.5	4	35
0.3	1	2.5	4	35
0.35	1	2.5	4	35
0.4	1	2.5	4	35
0.1	1	2.5	5	35
0.15	1	2.5	5	35
0.2	1	2.5	5	35
0.25	1	2.5	5	35
0.3	1	2.5	5	35
0.35	1	2.5	5	35
0.4	1	2.5	5	35
0.1	1	2.5	6	35
0.15	1	2.5	6	35
0.2	1	2.5	6	35
0.25	1	2.5	6	35
0.3	1	2.5	6	35
0.35	1	2.5	6	35
0.4	1	2.5	6	35
0.1	1	3	2	35
0.15	1	3	2	35
0.2	1	3	2	35
0.25	1	3	2	35
0.3	1	3	2	35
0.35	1	3	2	35
0.4	1	3	2	35
0.1	1	3	3	35

$\omega = \frac{Q}{v}$	$h = \frac{\omega}{b}$	$\chi = b + 2h$	$\frac{\omega^2}{\chi}$	$\Pi_k = \frac{v^2}{gh}$	$\sqrt{\Pi_k}$	$i = \frac{\Delta h}{L}$	$\Delta = \frac{8g \cdot \omega^2 - M + 2i^2}{Q^2 \cdot \chi - N \log i} \cdot h \cdot \frac{\chi}{b} \sqrt{\Pi_k}$	$\delta = 7\Delta$	uk.Dubina
0.3	0.12	2.74	0.032847	0.849473	0.921669	0.057143	0.184067876	1.288475	0.304068
0.35	0.14	2.78	0.044065	0.72812	0.853299	0.057143	0.198659935	1.39062	0.33866
0.4	0.16	2.82	0.056738	0.637105	0.798189	0.057143	0.212209532	1.485467	0.37221
0.1	0.04	2.58	0.003876	2.54842	1.596377	0.085714	0.125881213	0.881168	0.165881
0.15	0.06	2.62	0.008588	1.698947	1.303436	0.085714	0.154085244	1.078597	0.214085
0.2	0.08	2.66	0.015038	1.27421	1.128809	0.085714	0.177821711	1.244752	0.257822
0.25	0.1	2.7	0.023148	1.019368	1.009638	0.085714	0.198698239	1.390888	0.298698
0.3	0.12	2.74	0.032847	0.849473	0.921669	0.085714	0.217539802	1.522779	0.33754
0.35	0.14	2.78	0.044065	0.72812	0.853299	0.085714	0.234836756	1.643857	0.374837
0.4	0.16	2.82	0.056738	0.637105	0.798189	0.085714	0.250908777	1.756361	0.410909
0.1	0.04	2.58	0.003876	2.54842	1.596377	0.114286	0.143390292	1.003732	0.18339
0.15	0.06	2.62	0.008588	1.698947	1.303436	0.114286	0.17553329	1.228733	0.235533
0.2	0.08	2.66	0.015038	1.27421	1.128809	0.114286	0.202592274	1.418146	0.282592
0.25	0.1	2.7	0.023148	1.019368	1.009638	0.114286	0.226397592	1.584783	0.326398
0.3	0.12	2.74	0.032847	0.849473	0.921669	0.114286	0.247888424	1.735219	0.367888
0.35	0.14	2.78	0.044065	0.72812	0.853299	0.114286	0.267622957	1.873361	0.407623
0.4	0.16	2.82	0.056738	0.637105	0.798189	0.114286	0.285965053	2.001755	0.445965
0.1	0.04	2.58	0.003876	2.54842	1.596377	0.142857	0.160253552	1.121775	0.200254
0.15	0.06	2.62	0.008588	1.698947	1.303436	0.142857	0.196184916	1.373294	0.256185
0.2	0.08	2.66	0.015038	1.27421	1.128809	0.142857	0.226436909	1.585058	0.306437
0.25	0.1	2.7	0.023148	1.019368	1.009638	0.142857	0.253054685	1.771383	0.353055
0.3	0.12	2.74	0.032847	0.849473	0.921669	0.142857	0.277087593	1.939613	0.397088
0.35	0.14	2.78	0.044065	0.72812	0.853299	0.142857	0.299159273	2.094115	0.439159
0.4	0.16	2.82	0.056738	0.637105	0.798189	0.142857	0.319676238	2.237734	0.479676
0.1	0.04	2.58	0.003876	2.54842	1.596377	0.171429	0.177016047	1.239112	0.217016
0.15	0.06	2.62	0.008588	1.698947	1.303436	0.171429	0.216709638	1.516967	0.27671
0.2	0.08	2.66	0.015038	1.27421	1.128809	0.171429	0.250130977	1.750917	0.330131
0.25	0.1	2.7	0.023148	1.019368	1.009638	0.171429	0.279538928	1.956772	0.379539
0.3	0.12	2.74	0.032847	0.849473	0.921669	0.171429	0.306092475	2.142647	0.426092
0.35	0.14	2.78	0.044065	0.72812	0.853299	0.171429	0.3304804	2.313363	0.47048
0.4	0.16	2.82	0.056738	0.637105	0.798189	0.171429	0.353151672	2.472062	0.513152
0.1	0.033333	3.066667	0.003261	3.058104	1.748744	0.057143	0.096390266	0.674732	0.129724
0.15	0.05	3.1	0.007258	2.038736	1.427843	0.057143	0.117975747	0.82583	0.167976
0.2	0.066667	3.133333	0.012766	1.529052	1.236548	0.057143	0.136136896	0.952958	0.202804
0.25	0.083333	3.166667	0.019737	1.223242	1.106003	0.057143	0.152105319	1.064737	0.235439
0.3	0.1	3.2	0.028125	1.019368	1.009638	0.057143	0.166513092	1.165592	0.266513
0.35	0.116667	3.233333	0.037887	0.873744	0.934743	0.057143	0.179735951	1.258152	0.296403
0.4	0.133333	3.266667	0.04898	0.764526	0.874372	0.057143	0.19201887	1.344132	0.325352
0.1	0.033333	3.066667	0.003261	3.058104	1.748744	0.085714	0.114123206	0.798862	0.147457

Tip riblje staze:		normalna naizmjenična rebra
M	N	
0.077	18	

Q (m ³ /s)	v (m/s)	b (m)	pret. Δh	pretp. L
0.15	1	3	3	35
0.2	1	3	3	35
0.25	1	3	3	35
0.3	1	3	3	35
0.35	1	3	3	35
0.4	1	3	3	35
0.1	1	3	4	35
0.15	1	3	4	35
0.2	1	3	4	35
0.25	1	3	4	35
0.3	1	3	4	35
0.35	1	3	4	35
0.4	1	3	4	35
0.1	1	3	5	35
0.15	1	3	5	35
0.2	1	3	5	35
0.25	1	3	5	35
0.3	1	3	5	35
0.35	1	3	5	35
0.4	1	3	5	35
0.1	1	3	6	35
0.15	1	3	6	35
0.2	1	3	6	35
0.25	1	3	6	35
0.3	1	3	6	35
0.35	1	3	6	35
0.4	1	3	6	35
0.1	1	3.5	2	35
0.15	1	3.5	2	35
0.2	1	3.5	2	35
0.25	1	3.5	2	35
0.3	1	3.5	2	35
0.35	1	3.5	2	35
0.4	1	3.5	2	35
0.1	1	3.5	3	35
0.15	1	3.5	3	35
0.2	1	3.5	3	35
0.25	1	3.5	3	35
0.3	1	3.5	3	35

$\omega = \frac{Q}{v}$	$h = \frac{\omega}{b}$	$\chi = b + 2h$	$\frac{\omega^2}{\chi}$	$\Pi_k = \frac{v^2}{gh}$	$\sqrt{\Pi_k}$	$i = \frac{\Delta h}{L}$	$\Delta = \frac{8g \cdot \omega^2 - M + 2i^2}{Q^2 \cdot \chi - N \log i} \cdot h \cdot \frac{\chi}{b} \cdot \sqrt{\Pi_k}$	$\delta = 7\Delta$	uk.Dubina
0.15	0.05	3.1	0.007258	2.038736	1.427843	0.085714	0.139705533	0.977939	0.189706
0.2	0.066667	3.133333	0.012766	1.529052	1.236548	0.085714	0.161241523	1.128691	0.227908
0.25	0.083333	3.166667	0.019737	1.223242	1.106003	0.085714	0.180187938	1.261316	0.263521
0.3	0.1	3.2	0.028125	1.019368	1.009638	0.085714	0.197292265	1.381046	0.297292
0.35	0.116667	3.233333	0.037887	0.873744	0.934743	0.085714	0.21299876	1.490991	0.329665
0.4	0.133333	3.266667	0.04898	0.764526	0.874372	0.085714	0.227597021	1.593179	0.36093
0.1	0.033333	3.066667	0.003261	3.058104	1.748744	0.114286	0.130142014	0.910994	0.163475
0.15	0.05	3.1	0.007258	2.038736	1.427843	0.114286	0.159327446	1.115292	0.209327
0.2	0.066667	3.133333	0.012766	1.529052	1.236548	0.114286	0.183902373	1.287317	0.250569
0.25	0.083333	3.166667	0.019737	1.223242	1.106003	0.114286	0.205527359	1.438692	0.288861
0.3	0.1	3.2	0.028125	1.019368	1.009638	0.114286	0.225054395	1.575381	0.325054
0.35	0.116667	3.233333	0.037887	0.873744	0.934743	0.114286	0.242989809	1.700929	0.359656
0.4	0.133333	3.266667	0.04898	0.764526	0.874372	0.114286	0.259663633	1.817645	0.392997
0.1	0.033333	3.066667	0.003261	3.058104	1.748744	0.142857	0.145521801	1.018653	0.178855
0.15	0.05	3.1	0.007258	2.038736	1.427843	0.142857	0.17816257	1.247138	0.228163
0.2	0.066667	3.133333	0.012766	1.529052	1.236548	0.142857	0.205649927	1.439549	0.272317
0.25	0.083333	3.166667	0.019737	1.223242	1.106003	0.142857	0.229840327	1.608882	0.313174
0.3	0.1	3.2	0.028125	1.019368	1.009638	0.142857	0.251686233	1.761804	0.351686
0.35	0.116667	3.233333	0.037887	0.873744	0.934743	0.142857	0.271753663	1.902276	0.38842
0.4	0.133333	3.266667	0.04898	0.764526	0.874372	0.142857	0.290411542	2.032881	0.423745
0.1	0.033333	3.066667	0.003261	3.058104	1.748744	0.171429	0.160777929	1.125446	0.194111
0.15	0.05	3.1	0.007258	2.038736	1.427843	0.171429	0.196843587	1.377905	0.246844
0.2	0.066667	3.133333	0.012766	1.529052	1.236548	0.171429	0.227216464	1.590515	0.293883
0.25	0.083333	3.166667	0.019737	1.223242	1.106003	0.171429	0.253947481	1.777632	0.337281
0.3	0.1	3.2	0.028125	1.019368	1.009638	0.171429	0.278088856	1.946622	0.378089
0.35	0.116667	3.233333	0.037887	0.873744	0.934743	0.171429	0.300265877	2.101861	0.416933
0.4	0.133333	3.266667	0.04898	0.764526	0.874372	0.171429	0.320886098	2.246203	0.454219
0.1	0.028571	3.557143	0.002811	3.567788	1.888859	0.057143	0.088375384	0.618628	0.116947
0.15	0.042857	3.585714	0.006275	2.378525	1.542247	0.057143	0.108175609	0.757229	0.151033
0.2	0.057143	3.614286	0.011067	1.783894	1.335625	0.057143	0.124839202	0.873874	0.181982
0.25	0.071429	3.642857	0.017157	1.427115	1.194619	0.057143	0.139494831	0.976464	0.210923
0.3	0.085714	3.671429	0.024514	1.189263	1.090533	0.057143	0.15272169	1.069052	0.238436
0.35	0.1	3.7	0.033108	1.019368	1.009638	0.057143	0.164864048	1.154048	0.264864
0.4	0.114286	3.728571	0.042912	0.891947	0.944429	0.057143	0.176146344	1.233024	0.290432
0.1	0.028571	3.557143	0.002811	3.567788	1.888859	0.085714	0.104920348	0.734442	0.133492
0.15	0.042857	3.585714	0.006275	2.378525	1.542247	0.085714	0.128448062	0.899136	0.171305
0.2	0.057143	3.614286	0.011067	1.783894	1.335625	0.085714	0.148258314	1.037808	0.205401
0.25	0.071429	3.642857	0.017157	1.427115	1.194619	0.085714	0.165689934	1.15983	0.237119
0.3	0.085714	3.671429	0.024514	1.189263	1.090533	0.085714	0.181429847	1.270009	0.267144

PRILOG BROJ 1

Tip riblje staze:		normalna naizmjenična rebra
M	N	
0.077	18	

Q (m³/s)	v (m/s)	b (m)	pret. Δh	pretp. L
0.35	1	3.5	3	35
0.4	1	3.5	3	35
0.1	1	3.5	4	35
0.15	1	3.5	4	35
0.2	1	3.5	4	35
0.25	1	3.5	4	35
0.3	1	3.5	4	35
0.35	1	3.5	4	35
0.4	1	3.5	4	35
0.1	1	3.5	5	35
0.15	1	3.5	5	35
0.2	1	3.5	5	35
0.25	1	3.5	5	35
0.3	1	3.5	5	35
0.35	1	3.5	5	35
0.4	1	3.5	5	35
0.1	1	3.5	6	35
0.15	1	3.5	6	35
0.2	1	3.5	6	35
0.25	1	3.5	6	35
0.3	1	3.5	6	35
0.35	1	3.5	6	35
0.4	1	3.5	6	35
0.1	1	4	2	35
0.15	1	4	2	35
0.2	1	4	2	35
0.25	1	4	2	35
0.3	1	4	2	35
0.35	1	4	2	35
0.4	1	4	2	35
0.1	1	4	3	35
0.15	1	4	3	35
0.2	1	4	3	35
0.25	1	4	3	35
0.3	1	4	3	35
0.35	1	4	3	35
0.4	1	4	3	35
0.1	1	4	4	35
0.15	1	4	4	35

$\omega = \frac{Q}{v}$	$h = \frac{\omega}{b}$	$\chi = b + 2h$	$\frac{\omega^2}{\chi}$	$\Pi_k = \frac{v^2}{gh}$	$\sqrt{\Pi_k}$	$i = \frac{\Delta h}{L}$	$\Delta = \frac{8g \cdot \omega^2 - M + 2i^2}{Q^2 \cdot \chi - N \log i} \cdot h \cdot \frac{\chi}{b} \sqrt{\Pi_k}$	$\delta = 7\Delta$	uk.Dubina
0.35	0.1	3.7	0.033108	1.019368	1.009638	0.085714	0.195886291	1.371204	0.295886
0.4	0.114286	3.728571	0.042912	0.891947	0.944429	0.085714	0.209325365	1.465278	0.323611
0.1	0.028571	3.557143	0.002811	3.567788	1.888859	0.114286	0.119783799	0.838487	0.148355
0.15	0.042857	3.585714	0.006275	2.378525	1.542247	0.114286	0.146654347	1.02658	0.189511
0.2	0.057143	3.614286	0.011067	1.783894	1.335625	0.114286	0.169283832	1.184987	0.226427
0.25	0.071429	3.642857	0.017157	1.427115	1.194619	0.114286	0.189200209	1.324401	0.260629
0.3	0.085714	3.671429	0.024514	1.189263	1.090533	0.114286	0.207187385	1.450312	0.292902
0.35	0.1	3.7	0.033108	1.019368	1.009638	0.114286	0.223711198	1.565978	0.323711
0.4	0.114286	3.728571	0.042912	0.891947	0.944429	0.114286	0.239075277	1.673527	0.353361
0.1	0.028571	3.557143	0.002811	3.567788	1.888859	0.142857	0.134009473	0.938066	0.162581
0.15	0.042857	3.585714	0.006275	2.378525	1.542247	0.142857	0.164076223	1.148534	0.206933
0.2	0.057143	3.614286	0.011067	1.783894	1.335625	0.142857	0.189399791	1.325799	0.246543
0.25	0.071429	3.642857	0.017157	1.427115	1.194619	0.142857	0.211689316	1.481825	0.283118
0.3	0.085714	3.671429	0.024514	1.189263	1.090533	0.142857	0.23182163	1.622751	0.317536
0.35	0.1	3.7	0.033108	1.019368	1.009638	0.142857	0.250317782	1.752224	0.350318
0.4	0.114286	3.728571	0.042912	0.891947	0.944429	0.142857	0.267517368	1.872622	0.381803
0.1	0.028571	3.557143	0.002811	3.567788	1.888859	0.171429	0.148091106	1.036638	0.176663
0.15	0.042857	3.585714	0.006275	2.378525	1.542247	0.171429	0.181319577	1.269237	0.224177
0.2	0.057143	3.614286	0.011067	1.783894	1.335625	0.171429	0.209307176	1.46515	0.26645
0.25	0.071429	3.642857	0.017157	1.427115	1.194619	0.171429	0.233942506	1.637598	0.305371
0.3	0.085714	3.671429	0.024514	1.189263	1.090533	0.171429	0.256194461	1.793361	0.341909
0.35	0.1	3.7	0.033108	1.019368	1.009638	0.171429	0.276638784	1.936471	0.376639
0.4	0.114286	3.728571	0.042912	0.891947	0.944429	0.171429	0.295650717	2.069555	0.409936
0.1	0.025	4.05	0.002469	4.077472	2.019275	0.057143	0.081854859	0.572984	0.106855
0.15	0.0375	4.075	0.005521	2.718315	1.648731	0.057143	0.100200827	0.701406	0.137701
0.2	0.05	4.1	0.009756	2.038736	1.427843	0.057143	0.115643646	0.809506	0.165644
0.25	0.0625	4.125	0.015152	1.630989	1.277102	0.057143	0.129228343	0.904598	0.191728
0.3	0.075	4.15	0.021687	1.359157	1.165829	0.057143	0.141491151	0.990438	0.216491
0.35	0.0875	4.175	0.029341	1.164992	1.079348	0.057143	0.152750783	1.069255	0.240251
0.4	0.1	4.2	0.038095	1.019368	1.009638	0.057143	0.163215004	1.142505	0.263215
0.1	0.025	4.05	0.002469	4.077472	2.019275	0.085714	0.097451054	0.682157	0.122451
0.15	0.0375	4.075	0.005521	2.718315	1.648731	0.085714	0.11930963	0.835167	0.15681
0.2	0.05	4.1	0.009756	2.038736	1.427843	0.085714	0.137717185	0.96402	0.187717
0.25	0.0625	4.125	0.015152	1.630989	1.277102	0.085714	0.153916918	1.077418	0.216417
0.3	0.075	4.15	0.021687	1.359157	1.165829	0.085714	0.168546656	1.179827	0.243547
0.35	0.0875	4.175	0.029341	1.164992	1.079348	0.085714	0.181985437	1.273898	0.269485
0.4	0.1	4.2	0.038095	1.019368	1.009638	0.085714	0.194480316	1.361362	0.29448
0.1	0.025	4.05	0.002469	4.077472	2.019275	0.114286	0.11138548	0.779698	0.136385
0.15	0.0375	4.075	0.005521	2.718315	1.648731	0.114286	0.136377669	0.954644	0.173878

PRILOG BROJ 1

Tip riblje staze:		normalna naizmjenična rebra
M	N	
0.077	18	

Q (m ³ /s)	v (m/s)	b (m)	pret. Δh	pretp. L
0.2	1	4	4	35
0.25	1	4	4	35
0.3	1	4	4	35
0.35	1	4	4	35
0.4	1	4	4	35
0.1	1	4	5	35
0.15	1	4	5	35
0.2	1	4	5	35
0.25	1	4	5	35
0.3	1	4	5	35
0.35	1	4	5	35
0.4	1	4	5	35
0.1	1	4	6	35
0.15	1	4	6	35
0.2	1	4	6	35
0.25	1	4	6	35
0.3	1	4	6	35
0.35	1	4	6	35
0.4	1	4	6	35

$\omega = \frac{Q}{v}$	$h = \frac{\omega}{b}$	$\chi = b + 2h$	$\frac{\omega^2}{\chi}$	$\Pi_k = \frac{v^2}{gh}$	$\sqrt{\Pi_k}$	$i = \frac{\Delta h}{L}$	$\Delta = \frac{8g \cdot \omega^2 - M + 2i^2}{Q^2 \cdot \chi - N \log i} \cdot h \cdot \frac{\chi}{b} \cdot \sqrt{\Pi_k}$	$\delta = 7\Delta$	uk. Dubina
0.2	0.05	4.1	0.009756	2.038736	1.427843	0.114286	0.157427879	1.101995	0.207428
0.25	0.0625	4.125	0.015152	1.630989	1.277102	0.114286	0.175956625	1.231696	0.238457
0.3	0.075	4.15	0.021687	1.359157	1.165829	0.114286	0.192692663	1.348849	0.267693
0.35	0.0875	4.175	0.029341	1.164992	1.079348	0.114286	0.208069041	1.456483	0.295569
0.4	0.1	4.2	0.038095	1.019368	1.009638	0.114286	0.222368002	1.556576	0.322368
0.1	0.025	4.05	0.002469	4.077472	2.019275	0.142857	0.124679933	0.87276	0.14968
0.15	0.0375	4.075	0.005521	2.718315	1.648731	0.142857	0.152659208	1.068614	0.190159
0.2	0.05	4.1	0.009756	2.038736	1.427843	0.142857	0.176227288	1.233591	0.226227
0.25	0.0625	4.125	0.015152	1.630989	1.277102	0.142857	0.196974005	1.378818	0.259474
0.3	0.075	4.15	0.021687	1.359157	1.165829	0.142857	0.215714955	1.510005	0.290715
0.35	0.0875	4.175	0.029341	1.164992	1.079348	0.142857	0.232934778	1.630543	0.320435
0.4	0.1	4.2	0.038095	1.019368	1.009638	0.142857	0.24894933	1.742645	0.348949
0.1	0.025	4.05	0.002469	4.077472	2.019275	0.171429	0.137811866	0.964683	0.162812
0.15	0.0375	4.075	0.005521	2.718315	1.648731	0.171429	0.168739977	1.18118	0.20624
0.2	0.05	4.1	0.009756	2.038736	1.427843	0.171429	0.194792875	1.36355	0.244793
0.25	0.0625	4.125	0.015152	1.630989	1.277102	0.171429	0.217727736	1.524094	0.280228
0.3	0.075	4.15	0.021687	1.359157	1.165829	0.171429	0.238445995	1.669122	0.313446
0.35	0.0875	4.175	0.029341	1.164992	1.079348	0.171429	0.257483289	1.802383	0.344983
0.4	0.1	4.2	0.038095	1.019368	1.009638	0.171429	0.275188711	1.926321	0.375189

PRILOG BROJ 1

Tip riblje staze:		normalna naizmjenična rebra
M	N	
0.077	18	

Q (m ³ /s)	v (m/s)	b (m)	pret. Δh	pretp. L
0.1	0.3	2	2	35
0.15	0.3	2	2	35
0.2	0.3	2	2	35
0.25	0.3	2	2	35
0.3	0.3	2	2	35
0.35	0.3	2	2	35
0.4	0.3	2	2	35
0.1	0.3	2	3	35
0.15	0.3	2	3	35
0.2	0.3	2	3	35
0.25	0.3	2	3	35
0.3	0.3	2	3	35
0.35	0.3	2	3	35
0.4	0.3	2	3	35
0.1	0.3	2	4	35
0.15	0.3	2	4	35
0.2	0.3	2	4	35
0.25	0.3	2	4	35
0.3	0.3	2	4	35
0.35	0.3	2	4	35
0.4	0.3	2	4	35
0.1	0.3	2	5	35
0.15	0.3	2	5	35
0.2	0.3	2	5	35
0.25	0.3	2	5	35
0.3	0.3	2	5	35
0.35	0.3	2	5	35
0.4	0.3	2	5	35
0.1	0.3	2	6	35
0.15	0.3	2	6	35
0.2	0.3	2	6	35
0.25	0.3	2	6	35
0.3	0.3	2	6	35
0.35	0.3	2	6	35
0.4	0.3	2	6	35
0.1	0.3	2.5	2	35
0.15	0.3	2.5	2	35
0.2	0.3	2.5	2	35
0.25	0.3	2.5	2	35

$\omega = \frac{Q}{v}$	$h = \frac{\omega}{b}$	$\chi = b + 2h$	$\frac{\omega^2}{\chi}$	$\Pi_k = \frac{v^2}{gh}$	$\sqrt{\Pi_k}$	$i = \frac{\Delta h}{L}$	$\Delta = \frac{8g}{Q^2} \cdot \frac{\omega^2 - M + 2i^2}{\chi - N \log i} \cdot h \cdot \frac{\chi}{b} \cdot \sqrt{\Pi_k}$	$\delta = 7\Delta$	uk.Dubina
0.333333	0.166667	2.333333	0.047619	0.055046	0.234619	0.057143	0.758994469	5.312961	0.925661
0.5	0.25	2.5	0.1	0.036697	0.191565	0.057143	0.929313847	6.505197	1.179314
0.666667	0.333333	2.666667	0.166667	0.027523	0.1659	0.057143	1.072778126	7.509447	1.406111
0.833333	0.416667	2.833333	0.245098	0.022018	0.148386	0.057143	1.199065798	8.393461	1.615732
1	0.5	3	0.333333	0.018349	0.135457	0.057143	1.313142033	9.191994	1.813142
1.166667	0.583333	3.166667	0.429825	0.015727	0.125409	0.057143	1.417957221	9.925701	2.001291
1.333333	0.666667	3.333333	0.533333	0.013761	0.117309	0.057143	1.51543425	10.60804	2.182101
0.333333	0.166667	2.333333	0.047619	0.055046	0.234619	0.085714	0.885191822	6.196343	1.051858
0.5	0.25	2.5	0.1	0.036697	0.191565	0.085714	1.08391184	7.587383	1.333912
0.666667	0.333333	2.666667	0.166667	0.027523	0.1659	0.085714	1.25133689	8.759358	1.58467
0.833333	0.416667	2.833333	0.245098	0.022018	0.148386	0.085714	1.398750181	9.791251	1.815417
1	0.5	3	0.333333	0.018349	0.135457	0.085714	1.531939668	10.72358	2.03194
1.166667	0.583333	3.166667	0.429825	0.015727	0.125409	0.085714	1.654344384	11.58041	2.237678
1.333333	0.666667	3.333333	0.533333	0.013761	0.117309	0.085714	1.768205517	12.37744	2.434872
0.333333	0.166667	2.333333	0.047619	0.055046	0.234619	0.114286	1.003045505	7.021319	1.169712
0.5	0.25	2.5	0.1	0.036697	0.191565	0.114286	1.22826246	8.597837	1.478262
0.666667	0.333333	2.666667	0.166667	0.027523	0.1659	0.114286	1.418030091	9.926211	1.751363
0.833333	0.416667	2.833333	0.245098	0.022018	0.148386	0.114286	1.58513166	11.09592	2.001798
1	0.5	3	0.333333	0.018349	0.135457	0.114286	1.736124386	12.15287	2.236124
1.166667	0.583333	3.166667	0.429825	0.015727	0.125409	0.114286	1.874904248	13.12433	2.458238
1.333333	0.666667	3.333333	0.533333	0.013761	0.117309	0.114286	2.004010139	14.02807	2.670677
0.333333	0.166667	2.333333	0.047619	0.055046	0.234619	0.142857	1.118300589	7.828104	1.284967
0.5	0.25	2.5	0.1	0.036697	0.191565	0.142857	1.36941654	9.585916	1.619417
0.666667	0.333333	2.666667	0.166667	0.027523	0.1659	0.142857	1.581016172	11.06711	1.91435
0.833333	0.416667	2.833333	0.245098	0.022018	0.148386	0.142857	1.767350483	12.37145	2.184017
1	0.5	3	0.333333	0.018349	0.135457	0.142857	1.935729458	13.55011	2.435729
1.166667	0.583333	3.166667	0.429825	0.015727	0.125409	0.142857	2.090496267	14.63347	2.67383
1.333333	0.666667	3.333333	0.533333	0.013761	0.117309	0.142857	2.234481182	15.64137	2.901148
0.333333	0.166667	2.333333	0.047619	0.055046	0.234619	0.171429	1.234019799	8.638139	1.400686
0.5	0.25	2.5	0.1	0.036697	0.191565	0.171429	1.511130144	10.57791	1.76113
0.666667	0.333333	2.666667	0.166667	0.027523	0.1659	0.171429	1.744638045	12.21247	2.077971
0.833333	0.416667	2.833333	0.245098	0.022018	0.148386	0.171429	1.950268638	13.65188	2.366935
1	0.5	3	0.333333	0.018349	0.135457	0.171429	2.136088006	14.95262	2.636088
1.166667	0.583333	3.166667	0.429825	0.015727	0.125409	0.171429	2.30688852	16.14822	2.890222
1.333333	0.666667	3.333333	0.533333	0.013761	0.117309	0.171429	2.465793156	17.26055	3.13246
0.333333	0.133333	2.766667	0.040161	0.068807	0.262312	0.057143	0.678370211	4.748591	0.811704
0.5	0.2	2.9	0.086207	0.045872	0.214176	0.057143	0.830643869	5.814507	1.030644
0.666667	0.266667	3.033333	0.14652	0.034404	0.185482	0.057143	0.958929493	6.712506	1.225596
0.833333	0.333333	3.166667	0.219298	0.027523	0.1659	0.057143	1.071874907	7.503124	1.405208

Tip riblje staze:		normalna naizmjenična rebra
M	N	
0.077	18	

Q (m ³ /s)	v (m/s)	b (m)	pret. Δh	pretp. L
0.3	0.3	2.5	2	35
0.35	0.3	2.5	2	35
0.4	0.3	2.5	2	35
0.1	0.3	2.5	3	35
0.15	0.3	2.5	3	35
0.2	0.3	2.5	3	35
0.25	0.3	2.5	3	35
0.3	0.3	2.5	3	35
0.35	0.3	2.5	3	35
0.4	0.3	2.5	3	35
0.1	0.3	2.5	4	35
0.15	0.3	2.5	4	35
0.2	0.3	2.5	4	35
0.25	0.3	2.5	4	35
0.3	0.3	2.5	4	35
0.35	0.3	2.5	4	35
0.4	0.3	2.5	4	35
0.1	0.3	2.5	5	35
0.15	0.3	2.5	5	35
0.2	0.3	2.5	5	35
0.25	0.3	2.5	5	35
0.3	0.3	2.5	5	35
0.35	0.3	2.5	5	35
0.4	0.3	2.5	5	35
0.1	0.3	2.5	6	35
0.15	0.3	2.5	6	35
0.2	0.3	2.5	6	35
0.25	0.3	2.5	6	35
0.3	0.3	2.5	6	35
0.35	0.3	2.5	6	35
0.4	0.3	2.5	6	35
0.1	0.3	3	2	35
0.15	0.3	3	2	35
0.2	0.3	3	2	35
0.25	0.3	3	2	35
0.3	0.3	3	2	35
0.35	0.3	3	2	35
0.4	0.3	3	2	35
0.1	0.3	3	3	35

$\omega = \frac{Q}{v}$	$h = \frac{\omega}{b}$	$\chi = b + 2h$	$\frac{\omega^2}{\chi}$	$\Pi_k = \frac{v^2}{gh}$	$\sqrt{\Pi_k}$	$i = \frac{\Delta h}{L}$	$\Delta = \frac{8g \cdot \omega^2 - M + 2i^2}{-N \log i} \cdot h \cdot \frac{\chi}{b} \sqrt{\Pi_k}$	$\delta = 7\Delta$	uk.Dubina
1	0.4	3.3	0.30303	0.022936	0.151446	0.057143	1.173916284	8.217414	1.573916
1.166667	0.466667	3.433333	0.39644	0.019659	0.140211	0.057143	1.267689519	8.873827	1.734356
1.333333	0.533333	3.566667	0.498442	0.017202	0.131156	0.057143	1.354912437	9.484387	1.888246
0.333333	0.133333	2.766667	0.040161	0.068807	0.262312	0.085714	0.79131753	5.539223	0.924651
0.5	0.2	2.9	0.086207	0.045872	0.214176	0.085714	0.969003019	6.783021	1.169003
0.666667	0.266667	3.033333	0.14652	0.034404	0.185482	0.085714	1.118724632	7.831072	1.385391
0.833333	0.333333	3.166667	0.219298	0.027523	0.1659	0.085714	1.250566807	8.753968	1.5839
1	0.4	3.3	0.30303	0.022936	0.151446	0.085714	1.369702343	9.587916	1.769702
1.166667	0.466667	3.433333	0.39644	0.019659	0.140211	0.085714	1.47920464	10.35443	1.945871
1.333333	0.533333	3.566667	0.498442	0.017202	0.131156	0.085714	1.58107652	11.06754	2.11441
0.333333	0.133333	2.766667	0.040161	0.068807	0.262312	0.114286	0.896747916	6.277235	1.030081
0.5	0.2	2.9	0.086207	0.045872	0.214176	0.114286	1.098135446	7.686948	1.298135
0.666667	0.266667	3.033333	0.14652	0.034404	0.185482	0.114286	1.267842116	8.874895	1.534509
0.833333	0.333333	3.166667	0.219298	0.027523	0.1659	0.114286	1.417294392	9.921061	1.750628
1	0.4	3.3	0.30303	0.022936	0.151446	0.114286	1.552353307	10.86647	1.952353
1.166667	0.466667	3.433333	0.39644	0.019659	0.140211	0.114286	1.676501078	11.73551	2.143168
1.333333	0.533333	3.566667	0.498442	0.017202	0.131156	0.114286	1.792006882	12.54405	2.32534
0.333333	0.133333	2.766667	0.040161	0.068807	0.262312	0.142857	0.999827615	6.998793	1.133161
0.5	0.2	2.9	0.086207	0.045872	0.214176	0.142857	1.224378921	8.570652	1.424379
0.666667	0.266667	3.033333	0.14652	0.034404	0.185482	0.142857	1.413612225	9.895286	1.680279
0.833333	0.333333	3.166667	0.219298	0.027523	0.1659	0.142857	1.58026664	11.06187	1.9136
1	0.4	3.3	0.30303	0.022936	0.151446	0.142857	1.730876419	12.11613	2.130876
1.166667	0.466667	3.433333	0.39644	0.019659	0.140211	0.142857	1.869323713	13.08527	2.33599
1.333333	0.533333	3.566667	0.498442	0.017202	0.131156	0.142857	1.998138284	13.98697	2.531472
0.333333	0.133333	2.766667	0.040161	0.068807	0.262312	0.171429	1.103305519	7.723139	1.236639
0.5	0.2	2.9	0.086207	0.045872	0.214176	0.171429	1.351103719	9.457726	1.551104
0.666667	0.266667	3.033333	0.14652	0.034404	0.185482	0.171429	1.559930755	10.91952	1.826597
0.833333	0.333333	3.166667	0.219298	0.027523	0.1659	0.171429	1.743843808	12.20691	2.077177
1	0.4	3.3	0.30303	0.022936	0.151446	0.171429	1.910053169	13.37037	2.310053
1.166667	0.466667	3.433333	0.39644	0.019659	0.140211	0.171429	2.062842617	14.4399	2.529509
1.333333	0.533333	3.566667	0.498442	0.017202	0.131156	0.171429	2.205003615	15.43503	2.738337
0.333333	0.111111	3.222222	0.034483	0.082569	0.287348	0.057143	0.618789325	4.331525	0.7299
0.5	0.166667	3.333333	0.075	0.055046	0.234619	0.057143	0.757717125	5.30407	0.924384
0.666667	0.222222	3.444444	0.129032	0.041284	0.203186	0.057143	0.874772489	6.123407	1.096995
0.833333	0.277778	3.555556	0.195313	0.033028	0.181735	0.057143	0.977842148	6.844895	1.25562
1	0.333333	3.666667	0.272727	0.027523	0.1659	0.057143	1.070971689	7.496802	1.404305
1.166667	0.388889	3.777778	0.360294	0.023591	0.153594	0.057143	1.156564838	8.095954	1.545454
1.333333	0.444444	3.888889	0.457143	0.020642	0.143674	0.057143	1.236188053	8.653316	1.680632
0.333333	0.111111	3.222222	0.034483	0.082569	0.287348	0.085714	0.721965681	5.05376	0.833077

Tip riblje staze:		normalna naizmjenična rebra
M	N	
0.077	18	

Q (m ³ /s)	v (m/s)	b (m)	pret. Δh	pretp. L
0.15	0.3	3	3	35
0.2	0.3	3	3	35
0.25	0.3	3	3	35
0.3	0.3	3	3	35
0.35	0.3	3	3	35
0.4	0.3	3	3	35
0.1	0.3	3	4	35
0.15	0.3	3	4	35
0.2	0.3	3	4	35
0.25	0.3	3	4	35
0.3	0.3	3	4	35
0.35	0.3	3	4	35
0.4	0.3	3	4	35
0.1	0.3	3	5	35
0.15	0.3	3	5	35
0.2	0.3	3	5	35
0.25	0.3	3	5	35
0.3	0.3	3	5	35
0.35	0.3	3	5	35
0.4	0.3	3	5	35
0.1	0.3	3	6	35
0.15	0.3	3	6	35
0.2	0.3	3	6	35
0.25	0.3	3	6	35
0.3	0.3	3	6	35
0.35	0.3	3	6	35
0.4	0.3	3	6	35
0.1	0.3	3.5	2	35
0.15	0.3	3.5	2	35
0.2	0.3	3.5	2	35
0.25	0.3	3.5	2	35
0.3	0.3	3.5	2	35
0.35	0.3	3.5	2	35
0.4	0.3	3.5	2	35
0.1	0.3	3.5	3	35
0.15	0.3	3.5	3	35
0.2	0.3	3.5	3	35
0.25	0.3	3.5	3	35
0.3	0.3	3.5	3	35

$\omega = \frac{Q}{v}$	$h = \frac{\omega}{b}$	$\chi = b + 2h$	$\frac{\omega^2}{\chi}$	$\Pi_k = \frac{v^2}{gh}$	$\sqrt{\Pi_k}$	$i = \frac{\Delta h}{L}$	$\Delta = \frac{8g}{Q^2} \cdot \frac{\omega^2}{\chi} - \frac{M + 2i^2}{-N \log i} \cdot h \cdot \frac{\chi}{b} \cdot \sqrt{\Pi_k}$	$\delta = 7\Delta$	uk.Dubina
0.5	0.166667	3.333333	0.075	0.055046	0.234619	0.085714	0.884102759	6.188719	1.050769
0.666667	0.222222	3.444444	0.129032	0.041284	0.203186	0.085714	1.020734205	7.145139	1.242956
0.833333	0.277778	3.555556	0.195313	0.033028	0.181735	0.085714	1.141059315	7.987415	1.418837
1	0.333333	3.666667	0.272727	0.027523	0.1659	0.085714	1.249796723	8.748577	1.58313
1.166667	0.388889	3.777778	0.360294	0.023591	0.153594	0.085714	1.349749906	9.448249	1.738639
1.333333	0.444444	3.888889	0.457143	0.020642	0.143674	0.085714	1.442745741	10.09922	1.88719
0.333333	0.111111	3.222222	0.034483	0.082569	0.287348	0.114286	0.818228104	5.727597	0.929339
0.5	0.166667	3.333333	0.075	0.055046	0.234619	0.114286	1.002005069	7.014035	1.168672
0.666667	0.222222	3.444444	0.129032	0.041284	0.203186	0.114286	1.156882305	8.098176	1.379105
0.833333	0.277778	3.555556	0.195313	0.033028	0.181735	0.114286	1.293284494	9.052991	1.571062
1	0.333333	3.666667	0.272727	0.027523	0.1659	0.114286	1.416558693	9.915911	1.749892
1.166667	0.388889	3.777778	0.360294	0.023591	0.153594	0.114286	1.529881674	10.70917	1.918771
1.333333	0.444444	3.888889	0.457143	0.020642	0.143674	0.114286	1.635323524	11.44726	2.079768
0.333333	0.111111	3.222222	0.034483	0.082569	0.287348	0.142857	0.912319287	6.386235	1.02343
0.5	0.166667	3.333333	0.075	0.055046	0.234619	0.142857	1.117240591	7.820684	1.283907
0.666667	0.222222	3.444444	0.129032	0.041284	0.203186	0.142857	1.289942314	9.029596	1.512165
0.833333	0.277778	3.555556	0.195313	0.033028	0.181735	0.142857	1.4420473	10.09433	1.719825
1	0.333333	3.666667	0.272727	0.027523	0.1659	0.142857	1.579517108	11.05662	1.91285
1.166667	0.388889	3.777778	0.360294	0.023591	0.153594	0.142857	1.705893559	11.94125	2.094782
1.333333	0.444444	3.888889	0.457143	0.020642	0.143674	0.142857	1.823484595	12.76439	2.267929
0.333333	0.111111	3.222222	0.034483	0.082569	0.287348	0.171429	1.006757741	7.047304	1.117869
0.5	0.166667	3.333333	0.075	0.055046	0.234619	0.171429	1.232896578	8.630276	1.399563
0.666667	0.222222	3.444444	0.129032	0.041284	0.203186	0.171429	1.423482233	9.96437	1.645704
0.833333	0.277778	3.555556	0.195313	0.033028	0.181735	0.171429	1.5913404	11.13938	1.869118
1	0.333333	3.666667	0.272727	0.027523	0.1659	0.171429	1.74304957	12.20135	2.076383
1.166667	0.388889	3.777778	0.360294	0.023591	0.153594	0.171429	1.882518076	13.17763	2.271407
1.333333	0.444444	3.888889	0.457143	0.020642	0.143674	0.171429	2.012292675	14.08605	2.456737
0.333333	0.095238	3.690476	0.030108	0.09633	0.310371	0.057143	0.572435457	4.007048	0.667674
0.5	0.142857	3.785714	0.066038	0.06422	0.253417	0.057143	0.700974763	4.906823	0.843832
0.666667	0.190476	3.880952	0.114519	0.048165	0.219466	0.057143	0.809285885	5.665001	0.999762
0.833333	0.238095	3.97619	0.174651	0.038532	0.196296	0.057143	0.904663724	6.332646	1.142759
1	0.285714	4.071429	0.245614	0.03211	0.179193	0.057143	0.990850177	6.935951	1.276564
1.166667	0.333333	4.166667	0.326667	0.027523	0.1659	0.057143	1.07006847	7.490479	1.403402
1.333333	0.380952	4.261905	0.417132	0.024083	0.155186	0.057143	1.143767393	8.006372	1.52472
0.333333	0.095238	3.690476	0.030108	0.09633	0.310371	0.085714	0.668024847	4.676174	0.763263
0.5	0.142857	3.785714	0.066038	0.06422	0.253417	0.085714	0.818063979	5.726448	0.960921
0.666667	0.190476	3.880952	0.114519	0.048165	0.219466	0.085714	0.944508036	6.611556	1.134984
0.833333	0.238095	3.97619	0.174651	0.038532	0.196296	0.085714	1.055868117	7.391077	1.293963
1	0.285714	4.071429	0.245614	0.03211	0.179193	0.085714	1.156509769	8.095568	1.442224

PRILOG BROJ 1

Tip riblje staze:		normalna naizmjenična rebra
M	N	
0.077	18	

Q (m³/s)	v (m/s)	b (m)	pret. Δh	pretp. L
0.35	0.3	3.5	3	35
0.4	0.3	3.5	3	35
0.1	0.3	3.5	4	35
0.15	0.3	3.5	4	35
0.2	0.3	3.5	4	35
0.25	0.3	3.5	4	35
0.3	0.3	3.5	4	35
0.35	0.3	3.5	4	35
0.4	0.3	3.5	4	35
0.1	0.3	3.5	5	35
0.15	0.3	3.5	5	35
0.2	0.3	3.5	5	35
0.25	0.3	3.5	5	35
0.3	0.3	3.5	5	35
0.35	0.3	3.5	5	35
0.4	0.3	3.5	5	35
0.1	0.3	3.5	6	35
0.15	0.3	3.5	6	35
0.2	0.3	3.5	6	35
0.25	0.3	3.5	6	35
0.3	0.3	3.5	6	35
0.35	0.3	3.5	6	35
0.4	0.3	3.5	6	35
0.1	0.3	4	2	35
0.15	0.3	4	2	35
0.2	0.3	4	2	35
0.25	0.3	4	2	35
0.3	0.3	4	2	35
0.35	0.3	4	2	35
0.4	0.3	4	2	35
0.1	0.3	4	3	35
0.15	0.3	4	3	35
0.2	0.3	4	3	35
0.25	0.3	4	3	35
0.3	0.3	4	3	35
0.35	0.3	4	3	35
0.4	0.3	4	3	35
0.1	0.3	4	4	35
0.15	0.3	4	4	35

$\omega = \frac{Q}{v}$	$h = \frac{\omega}{b}$	$\chi = b + 2h$	$\frac{\omega^2}{\chi}$	$\Pi_k = \frac{v^2}{gh}$	$\sqrt{\Pi_k}$	$i = \frac{\Delta h}{L}$	$\Delta = \frac{8g \cdot \frac{\omega^2}{\chi} - M + 2i^2}{-N \log i} \cdot h \cdot \frac{\chi}{b} \sqrt{\Pi_k}$	$\delta = 7\Delta$	uk.Dubina
1.166667	0.333333	4.166667	0.326667	0.027523	0.1659	0.085714	1.249026639	8.743186	1.58236
1.333333	0.380952	4.261905	0.417132	0.024083	0.155186	0.085714	1.335108832	9.345762	1.716061
0.333333	0.095238	3.690476	0.030108	0.09633	0.310371	0.114286	0.757163745	5.300146	0.852402
0.5	0.142857	3.785714	0.066038	0.06422	0.253417	0.114286	0.927240675	6.490685	1.070098
0.666667	0.190476	3.880952	0.114519	0.048165	0.219466	0.114286	1.070579375	7.494056	1.261056
0.833333	0.238095	3.97619	0.174651	0.038532	0.196296	0.114286	1.196825695	8.37778	1.434921
1	0.285714	4.071429	0.245614	0.03211	0.179193	0.114286	1.310927123	9.17649	1.596641
1.166667	0.333333	4.166667	0.326667	0.027523	0.1659	0.114286	1.415822994	9.910761	1.749156
1.333333	0.380952	4.261905	0.417132	0.024083	0.155186	0.114286	1.513428638	10.594	1.894381
0.333333	0.095238	3.690476	0.030108	0.09633	0.310371	0.142857	0.84426833	5.909878	0.939506
0.5	0.142857	3.785714	0.066038	0.06422	0.253417	0.142857	1.033919843	7.237439	1.176777
0.666667	0.190476	3.880952	0.114519	0.048165	0.219466	0.142857	1.193759877	8.356319	1.384236
0.833333	0.238095	3.97619	0.174651	0.038532	0.196296	0.142857	1.334543456	9.341804	1.572639
1	0.285714	4.071429	0.245614	0.03211	0.179193	0.142857	1.461786932	10.23251	1.747501
1.166667	0.333333	4.166667	0.326667	0.027523	0.1659	0.142857	1.578767576	11.05137	1.912101
1.333333	0.380952	4.261905	0.417132	0.024083	0.155186	0.142857	1.687620907	11.81335	2.068573
0.333333	0.095238	3.690476	0.030108	0.09633	0.310371	0.171429	0.93167897	6.521753	1.026917
0.5	0.142857	3.785714	0.066038	0.06422	0.253417	0.171429	1.140970002	7.98679	1.283827
0.666667	0.190476	3.880952	0.114519	0.048165	0.219466	0.171429	1.317364316	9.22155	1.507841
0.833333	0.238095	3.97619	0.174651	0.038532	0.196296	0.171429	1.472730223	10.30911	1.710825
1	0.285714	4.071429	0.245614	0.03211	0.179193	0.171429	1.613155067	11.29209	1.898869
1.166667	0.333333	4.166667	0.326667	0.027523	0.1659	0.171429	1.742255333	12.19579	2.075589
1.333333	0.380952	4.261905	0.417132	0.024083	0.155186	0.171429	1.862387568	13.03671	2.24334
0.333333	0.083333	4.166667	0.026667	0.110092	0.331801	0.057143	0.535034235	3.74524	0.618368
0.5	0.125	4.25	0.058824	0.073394	0.270914	0.057143	0.655188251	4.586318	0.780188
0.666667	0.166667	4.333333	0.102564	0.055046	0.234619	0.057143	0.756439781	5.295078	0.923106
0.833333	0.208333	4.416667	0.157233	0.044037	0.209849	0.057143	0.845606376	5.919245	1.05394
1	0.25	4.5	0.222222	0.036697	0.191565	0.057143	0.926185005	6.483295	1.176185
1.166667	0.291667	4.583333	0.29697	0.031455	0.177355	0.057143	1.000253329	7.001773	1.29192
1.333333	0.333333	4.666667	0.380952	0.027523	0.1659	0.057143	1.069165251	7.484157	1.402499
0.333333	0.083333	4.166667	0.026667	0.110092	0.331801	0.085714	0.624513319	4.371593	0.707847
0.5	0.125	4.25	0.058824	0.073394	0.270914	0.085714	0.764790889	5.353536	0.889791
0.666667	0.166667	4.333333	0.102564	0.055046	0.234619	0.085714	0.883013696	6.181096	1.04968
0.833333	0.208333	4.416667	0.157233	0.044037	0.209849	0.085714	0.987137857	6.909965	1.195471
1	0.25	4.5	0.222222	0.036697	0.191565	0.085714	1.081244191	7.568709	1.331244
1.166667	0.291667	4.583333	0.29697	0.031455	0.177355	0.085714	1.167757148	8.1743	1.459424
1.333333	0.333333	4.666667	0.380952	0.027523	0.1659	0.085714	1.248256555	8.737796	1.58159
0.333333	0.083333	4.166667	0.026667	0.110092	0.331801	0.114286	0.707911497	4.95538	0.791245
0.5	0.125	4.25	0.058824	0.073394	0.270914	0.114286	0.866935888	6.068551	0.991936

PRILOG BROJ 1

Tip riblje staze:		normalna naizmjenična rebra
M	N	
0.077	18	

Q (m ³ /s)	v (m/s)	b (m)	pret. Δh	pretp. L
0.2	0.3	4	4	35
0.25	0.3	4	4	35
0.3	0.3	4	4	35
0.35	0.3	4	4	35
0.4	0.3	4	4	35
0.1	0.3	4	5	35
0.15	0.3	4	5	35
0.2	0.3	4	5	35
0.25	0.3	4	5	35
0.3	0.3	4	5	35
0.35	0.3	4	5	35
0.4	0.3	4	5	35
0.1	0.3	4	6	35
0.15	0.3	4	6	35
0.2	0.3	4	6	35
0.25	0.3	4	6	35
0.3	0.3	4	6	35
0.35	0.3	4	6	35
0.4	0.3	4	6	35

$\omega = \frac{Q}{v}$	$h = \frac{\omega}{b}$	$\chi = b + 2h$	$\frac{\omega^2}{\chi}$	$\Pi_k = \frac{v^2}{gh}$	$\sqrt{\Pi_k}$	$i = \frac{\Delta h}{L}$	$\Delta = \frac{8g}{Q^2} \cdot \frac{\omega^2}{\chi} - \frac{M + 2i^2}{i} - N \log i \cdot h \cdot \frac{\chi}{b} \cdot \sqrt{\Pi_k}$	$\delta = 7\Delta$	uk.Dubina
0.666667	0.166667	4.333333	0.102564	0.055046	0.234619	0.114286	1.000964634	7.006752	1.167631
0.833333	0.208333	4.416667	0.157233	0.044037	0.209849	0.114286	1.119015545	7.833109	1.327349
1	0.25	4.5	0.222222	0.036697	0.191565	0.114286	1.225713924	8.579997	1.475714
1.166667	0.291667	4.583333	0.29697	0.031455	0.177355	0.114286	1.323807654	9.266654	1.615474
1.333333	0.333333	4.666667	0.380952	0.027523	0.1659	0.114286	1.415087294	9.905611	1.748421
0.333333	0.083333	4.166667	0.026667	0.110092	0.331801	0.142857	0.789383788	5.525687	0.872717
0.5	0.125	4.25	0.058824	0.073394	0.270914	0.142857	0.966717247	6.767021	1.091717
0.666667	0.166667	4.333333	0.102564	0.055046	0.234619	0.142857	1.116180593	7.813264	1.282847
0.833333	0.208333	4.416667	0.157233	0.044037	0.209849	0.142857	1.247829081	8.734804	1.456162
1	0.25	4.5	0.222222	0.036697	0.191565	0.142857	1.366820085	9.567741	1.61682
1.166667	0.291667	4.583333	0.29697	0.031455	0.177355	0.142857	1.476217572	10.33352	1.767884
1.333333	0.333333	4.666667	0.380952	0.027523	0.1659	0.142857	1.578018044	11.04613	1.911351
0.333333	0.083333	4.166667	0.026667	0.110092	0.331801	0.171429	0.871127667	6.097894	0.954461
0.5	0.125	4.25	0.058824	0.073394	0.270914	0.171429	1.06682808	7.467797	1.191828
0.666667	0.166667	4.333333	0.102564	0.055046	0.234619	0.171429	1.231773357	8.622413	1.39844
0.833333	0.208333	4.416667	0.157233	0.044037	0.209849	0.171429	1.37705983	9.639419	1.585393
1	0.25	4.5	0.222222	0.036697	0.191565	0.171429	1.508378825	10.55865	1.758379
1.166667	0.291667	4.583333	0.29697	0.031455	0.177355	0.171429	1.629111517	11.40378	1.920778
1.333333	0.333333	4.666667	0.380952	0.027523	0.1659	0.171429	1.741461096	12.19023	2.074794

PRILOG BROJ 1

Tip riblje staze:		normalna naizmjenična rebra
M	N	
0.077	18	

Q (m ³ /s)	v (m/s)	b (m)	pret. Δh	pretp. L	$\omega = \frac{Q}{v}$	$h = \frac{\omega}{b}$	$\chi = b + 2h$	$\frac{\omega^2}{\chi}$	$\Pi_k = \frac{v^2}{gh}$	$\sqrt{\Pi_k}$	$i = \frac{\Delta h}{L}$	$\Delta = \frac{8g}{Q^2} \frac{\omega^2}{\chi} \frac{M + 2i^2}{i} \cdot h \frac{\chi}{b} \sqrt{\Pi_k}$	$\delta = 7\Delta$	uk.Dubina
0.1	0.5	2	2	35	0.2	0.1	2.2	0.018182	0.254842	0.504819	0.057143	0.350506053	2.453542	0.450506
0.15	0.5	2	2	35	0.3	0.15	2.3	0.03913	0.169895	0.412183	0.057143	0.429078524	3.00355	0.579079
0.2	0.5	2	2	35	0.4	0.2	2.4	0.066667	0.127421	0.356961	0.057143	0.495223993	3.466568	0.695224
0.25	0.5	2	2	35	0.5	0.25	2.5	0.1	0.101937	0.319275	0.057143	0.55341652	3.873916	0.803417
0.3	0.5	2	2	35	0.6	0.3	2.6	0.138462	0.084947	0.291457	0.057143	0.6059518	4.241663	0.905952
0.35	0.5	2	2	35	0.7	0.35	2.7	0.181481	0.072812	0.269837	0.057143	0.654194241	4.57936	1.004194
0.4	0.5	2	2	35	0.8	0.4	2.8	0.228571	0.06371	0.252409	0.057143	0.699033252	4.893233	1.099033
0.1	0.5	2	3	35	0.2	0.1	2.2	0.018182	0.254842	0.504819	0.085714	0.409487857	2.866415	0.509488
0.15	0.5	2	3	35	0.3	0.15	2.3	0.03913	0.169895	0.412183	0.085714	0.501345957	3.509422	0.651346
0.2	0.5	2	3	35	0.4	0.2	2.4	0.066667	0.127421	0.356961	0.085714	0.578705612	4.050939	0.778706
0.25	0.5	2	3	35	0.5	0.25	2.5	0.1	0.101937	0.319275	0.085714	0.646790239	4.527532	0.89679
0.3	0.5	2	3	35	0.6	0.3	2.6	0.138462	0.084947	0.291457	0.085714	0.708279686	4.957958	1.00828
0.35	0.5	2	3	35	0.7	0.35	2.7	0.181481	0.072812	0.269837	0.085714	0.764766464	5.353365	1.114766
0.4	0.5	2	3	35	0.8	0.4	2.8	0.228571	0.06371	0.252409	0.085714	0.817288545	5.72102	1.217289
0.1	0.5	2	4	35	0.2	0.1	2.2	0.018182	0.254842	0.504819	0.114286	0.464346677	3.250427	0.564347
0.15	0.5	2	4	35	0.3	0.15	2.3	0.03913	0.169895	0.412183	0.114286	0.568541704	3.979792	0.718542
0.2	0.5	2	4	35	0.4	0.2	2.4	0.066667	0.127421	0.356961	0.114286	0.656305455	4.594138	0.856305
0.25	0.5	2	4	35	0.5	0.25	2.5	0.1	0.101937	0.319275	0.114286	0.733559427	5.134916	0.983559
0.3	0.5	2	4	35	0.6	0.3	2.6	0.138462	0.084947	0.291457	0.114286	0.803341443	5.62339	1.103341
0.35	0.5	2	4	35	0.7	0.35	2.7	0.181481	0.072812	0.269837	0.114286	0.867456641	6.072196	1.217457
0.4	0.5	2	4	35	0.8	0.4	2.8	0.228571	0.06371	0.252409	0.114286	0.927081517	6.489571	1.327082
0.1	0.5	2	5	35	0.2	0.1	2.2	0.018182	0.254842	0.504819	0.142857	0.517878053	3.625146	0.617878
0.15	0.5	2	5	35	0.3	0.15	2.3	0.03913	0.169895	0.412183	0.142857	0.634100889	4.438706	0.784101
0.2	0.5	2	5	35	0.4	0.2	2.4	0.066667	0.127421	0.356961	0.142857	0.732003109	5.124022	0.932003
0.25	0.5	2	5	35	0.5	0.25	2.5	0.1	0.101937	0.319275	0.142857	0.818187985	5.727316	1.068188
0.3	0.5	2	5	35	0.6	0.3	2.6	0.138462	0.084947	0.291457	0.142857	0.896043008	6.272301	1.196043
0.35	0.5	2	5	35	0.7	0.35	2.7	0.181481	0.072812	0.269837	0.142857	0.967581051	6.773067	1.317581
0.4	0.5	2	5	35	0.8	0.4	2.8	0.228571	0.06371	0.252409	0.142857	1.034113963	7.238798	1.434114
0.1	0.5	2	6	35	0.2	0.1	2.2	0.018182	0.254842	0.504819	0.171429	0.571548478	4.000839	0.671548
0.15	0.5	2	6	35	0.3	0.15	2.3	0.03913	0.169895	0.412183	0.171429	0.69982347	4.898764	0.849823
0.2	0.5	2	6	35	0.4	0.2	2.4	0.066667	0.127421	0.356961	0.171429	0.807881466	5.65517	1.007881
0.25	0.5	2	6	35	0.5	0.25	2.5	0.1	0.101937	0.319275	0.171429	0.903009661	6.321068	1.15301
0.3	0.5	2	6	35	0.6	0.3	2.6	0.138462	0.084947	0.291457	0.171429	0.988946363	6.922625	1.288946
0.35	0.5	2	6	35	0.7	0.35	2.7	0.181481	0.072812	0.269837	0.171429	1.067912873	7.47539	1.417913
0.4	0.5	2	6	35	0.8	0.4	2.8	0.228571	0.06371	0.252409	0.171429	1.141356868	7.989498	1.541357
0.1	0.5	2.5	2	35	0.2	0.08	2.66	0.015038	0.318552	0.564405	0.057143	0.312823667	2.189766	0.392824
0.15	0.5	2.5	2	35	0.3	0.12	2.74	0.032847	0.212368	0.460834	0.057143	0.382984667	2.680893	0.502985
0.2	0.5	2.5	2	35	0.4	0.16	2.82	0.056738	0.159276	0.399094	0.057143	0.442065729	3.09446	0.602066
0.25	0.5	2.5	2	35	0.5	0.2	2.9	0.086207	0.127421	0.356961	0.057143	0.494057943	3.458406	0.694058

Tip riblje staze:		normalna naizmjenična rebra
M	N	
0.077	18	

Q (m ³ /s)	v (m/s)	b (m)	pret. Δh	pretp. L	$\omega = \frac{Q}{v}$	$h = \frac{\omega}{b}$	$\chi = b + 2h$	$\frac{\omega^2}{\chi}$	$\Pi_k = \frac{v^2}{gh}$	$\sqrt{\Pi_k}$	$i = \frac{\Delta h}{L}$	$\Delta = \frac{8g}{Q^2} \frac{\omega^2}{\chi} \frac{M + 2i^2}{-N \log i} \cdot h \frac{\chi}{b} \sqrt{\Pi_k}$	$\delta = 7\Delta$	uk.Dubina
0.3	0.5	2.5	2	35	0.6	0.24	2.98	0.120805	0.106184	0.325859	0.057143	0.541008985	3.787063	0.781009
0.35	0.5	2.5	2	35	0.7	0.28	3.06	0.160131	0.091015	0.301687	0.057143	0.584135741	4.08895	0.864136
0.4	0.5	2.5	2	35	0.8	0.32	3.14	0.203822	0.079638	0.282202	0.057143	0.624231382	4.36962	0.944231
0.1	0.5	2.5	3	35	0.2	0.08	2.66	0.015038	0.318552	0.564405	0.085714	0.365678605	2.55975	0.445679
0.15	0.5	2.5	3	35	0.3	0.12	2.74	0.032847	0.212368	0.460834	0.085714	0.447739782	3.134178	0.56774
0.2	0.5	2.5	3	35	0.4	0.16	2.82	0.056738	0.159276	0.399094	0.085714	0.516863093	3.618042	0.676863
0.25	0.5	2.5	3	35	0.5	0.2	2.9	0.086207	0.127421	0.356961	0.085714	0.577711438	4.04398	0.777711
0.3	0.5	2.5	3	35	0.6	0.24	2.98	0.120805	0.106184	0.325859	0.085714	0.632676922	4.428738	0.872677
0.35	0.5	2.5	3	35	0.7	0.28	3.06	0.160131	0.091015	0.301687	0.085714	0.683180968	4.782267	0.963181
0.4	0.5	2.5	3	35	0.8	0.32	3.14	0.203822	0.079638	0.282202	0.085714	0.730149969	5.11105	1.05015
0.1	0.5	2.5	4	35	0.2	0.08	2.66	0.015038	0.318552	0.564405	0.114286	0.414771654	2.903402	0.494772
0.15	0.5	2.5	4	35	0.3	0.12	2.74	0.032847	0.212368	0.460834	0.114286	0.507871744	3.555102	0.627872
0.2	0.5	2.5	4	35	0.4	0.16	2.82	0.056738	0.159276	0.399094	0.114286	0.586303854	4.104127	0.746304
0.25	0.5	2.5	4	35	0.5	0.2	2.9	0.086207	0.127421	0.356961	0.114286	0.655355671	4.58749	0.855356
0.3	0.5	2.5	4	35	0.6	0.24	2.98	0.120805	0.106184	0.325859	0.114286	0.717739699	5.024178	0.95774
0.35	0.5	2.5	4	35	0.7	0.28	3.06	0.160131	0.091015	0.301687	0.114286	0.775067671	5.425474	1.055068
0.4	0.5	2.5	4	35	0.8	0.32	3.14	0.203822	0.079638	0.282202	0.114286	0.828389971	5.79873	1.14839
0.1	0.5	2.5	5	35	0.2	0.08	2.66	0.015038	0.318552	0.564405	0.142857	0.462641181	3.238488	0.542641
0.15	0.5	2.5	5	35	0.3	0.12	2.74	0.032847	0.212368	0.460834	0.142857	0.566497489	3.965482	0.686497
0.2	0.5	2.5	5	35	0.4	0.16	2.82	0.056738	0.159276	0.399094	0.142857	0.653996478	4.577975	0.813996
0.25	0.5	2.5	5	35	0.5	0.2	2.9	0.086207	0.127421	0.356961	0.142857	0.731035468	5.117248	0.931035
0.3	0.5	2.5	5	35	0.6	0.24	2.98	0.120805	0.106184	0.325859	0.142857	0.800639632	5.604477	1.04064
0.35	0.5	2.5	5	35	0.7	0.28	3.06	0.160131	0.091015	0.301687	0.142857	0.864606453	6.052245	1.144606
0.4	0.5	2.5	5	35	0.8	0.32	3.14	0.203822	0.079638	0.282202	0.142857	0.924107341	6.468751	1.244107
0.1	0.5	2.5	6	35	0.2	0.08	2.66	0.015038	0.318552	0.564405	0.171429	0.510611887	3.574283	0.590612
0.15	0.5	2.5	6	35	0.3	0.12	2.74	0.032847	0.212368	0.460834	0.171429	0.625242211	4.376695	0.745242
0.2	0.5	2.5	6	35	0.4	0.16	2.82	0.056738	0.159276	0.399094	0.171429	0.721820781	5.052745	0.881821
0.25	0.5	2.5	6	35	0.5	0.2	2.9	0.086207	0.127421	0.356961	0.171429	0.80685611	5.647993	1.006856
0.3	0.5	2.5	6	35	0.6	0.24	2.98	0.120805	0.106184	0.325859	0.171429	0.883686869	6.185808	1.123687
0.35	0.5	2.5	6	35	0.7	0.28	3.06	0.160131	0.091015	0.301687	0.171429	0.954296795	6.680078	1.234297
0.4	0.5	2.5	6	35	0.8	0.32	3.14	0.203822	0.079638	0.282202	0.171429	1.019978669	7.139851	1.339979
0.1	0.5	3	2	35	0.2	0.066667	3.133333	0.012766	0.382263	0.618274	0.057143	0.284930317	1.994512	0.351597
0.15	0.5	3	2	35	0.3	0.1	3.2	0.028125	0.254842	0.504819	0.057143	0.348857008	2.441999	0.448857
0.2	0.5	3	2	35	0.4	0.133333	3.266667	0.04898	0.191131	0.437186	0.057143	0.402698432	2.818889	0.536032
0.25	0.5	3	2	35	0.5	0.166667	3.333333	0.075	0.152905	0.391031	0.057143	0.450088607	3.15062	0.616755
0.3	0.5	3	2	35	0.6	0.2	3.4	0.105882	0.127421	0.356961	0.057143	0.492891892	3.450243	0.692892
0.35	0.5	3	2	35	0.7	0.233333	3.466667	0.141346	0.109218	0.330481	0.057143	0.532216161	3.725513	0.765549
0.4	0.5	3	2	35	0.8	0.266667	3.533333	0.181132	0.095566	0.309137	0.057143	0.568783483	3.981484	0.83545
0.1	0.5	3	3	35	0.2	0.066667	3.133333	0.012766	0.382263	0.618274	0.085714	0.333273994	2.332918	0.399941

PRILOG BROJ 1

Tip riblje staze:		normalna naizmjenična rebra
M	N	
0.077	18	

Q (m ³ /s)	v (m/s)	b (m)	pret. Δh	pretp. L	$\omega = \frac{Q}{v}$	$h = \frac{\omega}{b}$	$\chi = b + 2h$	$\frac{\omega^2}{\chi}$	$\Pi_k = \frac{v^2}{gh}$	$\sqrt{\Pi_k}$	$i = \frac{\Delta h}{L}$	$\Delta = \frac{8g}{Q^2} \frac{\omega^2}{\chi} \frac{M + 2i^2}{-N \log i} \cdot h \frac{\chi}{b} \sqrt{\Pi_k}$	$\delta = 7\Delta$	uk.Dubina
0.15	0.5	3	3	35	0.3	0.1	3.2	0.028125	0.254842	0.504819	0.085714	0.408081883	2.856573	0.508082
0.2	0.5	3	3	35	0.4	0.133333	3.266667	0.04898	0.191131	0.437186	0.085714	0.471104138	3.297729	0.604437
0.25	0.5	3	3	35	0.5	0.166667	3.333333	0.075	0.152905	0.391031	0.085714	0.526589431	3.686126	0.693256
0.3	0.5	3	3	35	0.6	0.2	3.4	0.105882	0.127421	0.356961	0.085714	0.576717264	4.037021	0.776717
0.35	0.5	3	3	35	0.7	0.233333	3.466667	0.141346	0.109218	0.330481	0.085714	0.622782663	4.359479	0.856116
0.4	0.5	3	3	35	0.8	0.266667	3.533333	0.181132	0.095566	0.309137	0.085714	0.665629609	4.659407	0.932296
0.1	0.5	3	4	35	0.2	0.066667	3.133333	0.012766	0.382263	0.618274	0.114286	0.378113873	2.646797	0.444781
0.15	0.5	3	4	35	0.3	0.1	3.2	0.028125	0.254842	0.504819	0.114286	0.46300348	3.241024	0.563003
0.2	0.5	3	4	35	0.4	0.133333	3.266667	0.04898	0.191131	0.437186	0.114286	0.534526968	3.741689	0.66786
0.25	0.5	3	4	35	0.5	0.166667	3.333333	0.075	0.152905	0.391031	0.114286	0.597503714	4.182526	0.76417
0.3	0.5	3	4	35	0.6	0.2	3.4	0.105882	0.127421	0.356961	0.114286	0.654405887	4.580841	0.854406
0.35	0.5	3	4	35	0.7	0.233333	3.466667	0.141346	0.109218	0.330481	0.114286	0.70670236	4.946917	0.940036
0.4	0.5	3	4	35	0.8	0.266667	3.533333	0.181132	0.095566	0.309137	0.114286	0.755350373	5.287453	1.022017
0.1	0.5	3	5	35	0.2	0.066667	3.133333	0.012766	0.382263	0.618274	0.142857	0.421802812	2.95262	0.488469
0.15	0.5	3	5	35	0.3	0.1	3.2	0.028125	0.254842	0.504819	0.142857	0.516509601	3.615567	0.61651
0.2	0.5	3	5	35	0.4	0.133333	3.266667	0.04898	0.191131	0.437186	0.142857	0.596308571	4.17416	0.729642
0.25	0.5	3	5	35	0.5	0.166667	3.333333	0.075	0.152905	0.391031	0.142857	0.666575473	4.666028	0.833242
0.3	0.5	3	5	35	0.6	0.2	3.4	0.105882	0.127421	0.356961	0.142857	0.730067826	5.110475	0.930068
0.35	0.5	3	5	35	0.7	0.233333	3.466667	0.141346	0.109218	0.330481	0.142857	0.788424023	5.518968	1.021757
0.4	0.5	3	5	35	0.8	0.266667	3.533333	0.181132	0.095566	0.309137	0.142857	0.842711756	5.898982	1.109378
0.1	0.5	3	6	35	0.2	0.066667	3.133333	0.012766	0.382263	0.618274	0.171429	0.465562331	3.258936	0.532229
0.15	0.5	3	6	35	0.3	0.1	3.2	0.028125	0.254842	0.504819	0.171429	0.570098405	3.990689	0.670098
0.2	0.5	3	6	35	0.4	0.133333	3.266667	0.04898	0.191131	0.437186	0.171429	0.658181309	4.607269	0.791515
0.25	0.5	3	6	35	0.5	0.166667	3.333333	0.075	0.152905	0.391031	0.171429	0.735744272	5.15021	0.902411
0.3	0.5	3	6	35	0.6	0.2	3.4	0.105882	0.127421	0.356961	0.171429	0.805830754	5.640815	1.005831
0.35	0.5	3	6	35	0.7	0.233333	3.466667	0.141346	0.109218	0.330481	0.171429	0.870249026	6.091743	1.103582
0.4	0.5	3	6	35	0.8	0.266667	3.533333	0.181132	0.095566	0.309137	0.171429	0.930177478	6.511242	1.196844
0.1	0.5	3.5	2	35	0.2	0.057143	3.614286	0.011067	0.445973	0.667812	0.057143	0.263194679	1.842363	0.320338
0.15	0.5	3.5	2	35	0.3	0.085714	3.671429	0.024514	0.297316	0.545267	0.057143	0.322259092	2.255814	0.407973
0.2	0.5	3.5	2	35	0.4	0.114286	3.728571	0.042912	0.222987	0.472215	0.057143	0.372012009	2.604084	0.486298
0.25	0.5	3.5	2	35	0.5	0.142857	3.785714	0.066038	0.178389	0.422362	0.057143	0.415809443	2.910666	0.558667
0.3	0.5	3.5	2	35	0.6	0.171429	3.842857	0.09368	0.148658	0.385562	0.057143	0.455373046	3.187611	0.626802
0.35	0.5	3.5	2	35	0.7	0.2	3.9	0.125641	0.127421	0.356961	0.057143	0.491725842	3.442081	0.691726
0.4	0.5	3.5	2	35	0.8	0.228571	3.957143	0.161733	0.111493	0.333906	0.057143	0.525534573	3.678742	0.754106
0.1	0.5	3.5	3	35	0.2	0.057143	3.614286	0.011067	0.445973	0.667812	0.085714	0.308040598	2.156284	0.365183
0.15	0.5	3.5	3	35	0.3	0.085714	3.671429	0.024514	0.297316	0.545267	0.085714	0.377196761	2.640377	0.462911
0.2	0.5	3.5	3	35	0.4	0.114286	3.728571	0.042912	0.222987	0.472215	0.085714	0.435463414	3.048244	0.549749
0.25	0.5	3.5	3	35	0.5	0.142857	3.785714	0.066038	0.178389	0.422362	0.085714	0.486766871	3.407368	0.629624
0.3	0.5	3.5	3	35	0.6	0.171429	3.842857	0.09368	0.148658	0.385562	0.085714	0.5331212	3.731848	0.70455

Tip riblje staze:		normalna naizmjenična rebra
M	N	
0.077	18	

Q (m ³ /s)	v (m/s)	b (m)	pret. Δh	pretp. L	$\omega = \frac{Q}{v}$	$h = \frac{\omega}{b}$	$\chi = b + 2h$	$\frac{\omega^2}{\chi}$	$\Pi_k = \frac{v^2}{gh}$	$\sqrt{\Pi_k}$	$i = \frac{\Delta h}{L}$	$\Delta = \frac{8g}{Q^2} \frac{\omega^2}{\chi} \frac{M + 2i^2}{-N \log i} \cdot h \frac{\chi}{b} \sqrt{\Pi_k}$	$\delta = 7\Delta$	uk.Dubina
0.35	0.5	3.5	3	35	0.7	0.2	3.9	0.125641	0.127421	0.356961	0.085714	0.57572309	4.030062	0.775723
0.4	0.5	3.5	3	35	0.8	0.228571	3.957143	0.161733	0.111493	0.333906	0.085714	0.615352407	4.307467	0.843924
0.1	0.5	3.5	4	35	0.2	0.057143	3.614286	0.011067	0.445973	0.667812	0.114286	0.349577083	2.44704	0.40672
0.15	0.5	3.5	4	35	0.3	0.085714	3.671429	0.024514	0.297316	0.545267	0.114286	0.428071679	2.996502	0.513786
0.2	0.5	3.5	4	35	0.4	0.114286	3.728571	0.042912	0.222987	0.472215	0.114286	0.494212545	3.459488	0.608498
0.25	0.5	3.5	4	35	0.5	0.142857	3.785714	0.066038	0.178389	0.422362	0.114286	0.552454684	3.867183	0.695312
0.3	0.5	3.5	4	35	0.6	0.171429	3.842857	0.09368	0.148658	0.385562	0.114286	0.60508329	4.235583	0.776512
0.35	0.5	3.5	4	35	0.7	0.2	3.9	0.125641	0.127421	0.356961	0.114286	0.653456104	4.574193	0.853456
0.4	0.5	3.5	4	35	0.8	0.228571	3.957143	0.161733	0.111493	0.333906	0.114286	0.698457918	4.889205	0.927029
0.1	0.5	3.5	5	35	0.2	0.057143	3.614286	0.011067	0.445973	0.667812	0.142857	0.390016	2.730112	0.447159
0.15	0.5	3.5	5	35	0.3	0.085714	3.671429	0.024514	0.297316	0.545267	0.142857	0.477597699	3.343184	0.563312
0.2	0.5	3.5	5	35	0.4	0.114286	3.728571	0.042912	0.222987	0.472215	0.142857	0.551398724	3.859791	0.665684
0.25	0.5	3.5	5	35	0.5	0.142857	3.785714	0.066038	0.178389	0.422362	0.142857	0.616389051	4.314723	0.759246
0.3	0.5	3.5	5	35	0.6	0.171429	3.842857	0.09368	0.148658	0.385562	0.142857	0.67511799	4.725826	0.846547
0.35	0.5	3.5	5	35	0.7	0.2	3.9	0.125641	0.127421	0.356961	0.142857	0.729100185	5.103701	0.9291
0.4	0.5	3.5	5	35	0.8	0.228571	3.957143	0.161733	0.111493	0.333906	0.142857	0.779322661	5.455259	1.007894
0.1	0.5	3.5	6	35	0.2	0.057143	3.614286	0.011067	0.445973	0.667812	0.171429	0.430499767	3.013498	0.487643
0.15	0.5	3.5	6	35	0.3	0.085714	3.671429	0.024514	0.297316	0.545267	0.171429	0.527175667	3.69023	0.61289
0.2	0.5	3.5	6	35	0.4	0.114286	3.728571	0.042912	0.222987	0.472215	0.171429	0.608641444	4.26049	0.722927
0.25	0.5	3.5	6	35	0.5	0.142857	3.785714	0.066038	0.178389	0.422362	0.171429	0.680382783	4.762679	0.82324
0.3	0.5	3.5	6	35	0.6	0.171429	3.842857	0.09368	0.148658	0.385562	0.171429	0.745213505	5.216495	0.916642
0.35	0.5	3.5	6	35	0.7	0.2	3.9	0.125641	0.127421	0.356961	0.171429	0.804805398	5.633638	1.004805
0.4	0.5	3.5	6	35	0.8	0.228571	3.957143	0.161733	0.111493	0.333906	0.171429	0.860247887	6.021735	1.088819
0.1	0.5	4	2	35	0.2	0.05	4.1	0.009756	0.509684	0.713922	0.057143	0.245629711	1.719408	0.29563
0.15	0.5	4	2	35	0.3	0.075	4.15	0.021687	0.339789	0.582915	0.057143	0.300762323	2.105336	0.375762
0.2	0.5	4	2	35	0.4	0.1	4.2	0.038095	0.254842	0.504819	0.057143	0.347207964	2.430456	0.447208
0.25	0.5	4	2	35	0.5	0.125	4.25	0.058824	0.203874	0.451524	0.057143	0.388098121	2.716687	0.513098
0.3	0.5	4	2	35	0.6	0.15	4.3	0.083721	0.169895	0.412183	0.057143	0.425039208	2.975274	0.575039
0.35	0.5	4	2	35	0.7	0.175	4.35	0.112644	0.145624	0.381607	0.057143	0.458985741	3.2129	0.633986
0.4	0.5	4	2	35	0.8	0.2	4.4	0.145455	0.127421	0.356961	0.057143	0.490559792	3.433919	0.69056
0.1	0.5	4	3	35	0.2	0.05	4.1	0.009756	0.509684	0.713922	0.085714	0.28766271	2.013639	0.337663
0.15	0.5	4	3	35	0.3	0.075	4.15	0.021687	0.339789	0.582915	0.085714	0.352252548	2.465768	0.427253
0.2	0.5	4	3	35	0.4	0.1	4.2	0.038095	0.254842	0.504819	0.085714	0.406675909	2.846731	0.506676
0.25	0.5	4	3	35	0.5	0.125	4.25	0.058824	0.203874	0.451524	0.085714	0.454598892	3.182192	0.579599
0.3	0.5	4	3	35	0.6	0.15	4.3	0.083721	0.169895	0.412183	0.085714	0.497902037	3.485314	0.647902
0.35	0.5	4	3	35	0.7	0.175	4.35	0.112644	0.145624	0.381607	0.085714	0.53770267	3.763919	0.712703
0.4	0.5	4	3	35	0.8	0.2	4.4	0.145455	0.127421	0.356961	0.085714	0.574728916	4.023102	0.774729
0.1	0.5	4	4	35	0.2	0.05	4.1	0.009756	0.509684	0.713922	0.114286	0.326538095	2.285767	0.376538
0.15	0.5	4	4	35	0.3	0.075	4.15	0.021687	0.339789	0.582915	0.114286	0.399867695	2.799074	0.474868

PRILOG BROJ 1

Tip riblje staze:		normalna naizmjenična rebra
M	N	
0.077	18	

Q (m ³ /s)	v (m/s)	b (m)	pret. Δh	pretp. L	$\omega = \frac{Q}{v}$	$h = \frac{\omega}{b}$	$\chi = b + 2h$	$\frac{\omega^2}{\chi}$	$\Pi_k = \frac{v^2}{gh}$	$\sqrt{\Pi_k}$	$i = \frac{\Delta h}{L}$	$\Delta = \frac{8g}{Q^2} \frac{\omega^2}{\chi} \frac{M + 2i^2}{-N \log i} \cdot h \frac{\chi}{b} \sqrt{\Pi_k}$	$\delta = 7\Delta$	uk.Dubina
0.2	0.5	4	4	35	0.4	0.1	4.2	0.038095	0.254842	0.504819	0.114286	0.461660283	3.231622	0.56166
0.25	0.5	4	4	35	0.5	0.125	4.25	0.058824	0.203874	0.451524	0.114286	0.516076801	3.612538	0.641077
0.3	0.5	4	4	35	0.6	0.15	4.3	0.083721	0.169895	0.412183	0.114286	0.565251557	3.956761	0.715252
0.35	0.5	4	4	35	0.7	0.175	4.35	0.112644	0.145624	0.381607	0.114286	0.610452617	4.273168	0.785453
0.4	0.5	4	4	35	0.8	0.2	4.4	0.145455	0.127421	0.356961	0.114286	0.65250632	4.567544	0.852506
0.1	0.5	4	5	35	0.2	0.05	4.1	0.009756	0.509684	0.713922	0.142857	0.364356564	2.550496	0.414357
0.15	0.5	4	5	35	0.3	0.075	4.15	0.021687	0.339789	0.582915	0.142857	0.446184578	3.123292	0.521185
0.2	0.5	4	5	35	0.4	0.1	4.2	0.038095	0.254842	0.504819	0.142857	0.51514115	3.605988	0.615141
0.25	0.5	4	5	35	0.5	0.125	4.25	0.058824	0.203874	0.451524	0.142857	0.575868815	4.031082	0.700869
0.3	0.5	4	5	35	0.6	0.15	4.3	0.083721	0.169895	0.412183	0.142857	0.630748881	4.415242	0.780749
0.35	0.5	4	5	35	0.7	0.175	4.35	0.112644	0.145624	0.381607	0.142857	0.681196142	4.768373	0.856196
0.4	0.5	4	5	35	0.8	0.2	4.4	0.145455	0.127421	0.356961	0.142857	0.728132544	5.096928	0.928133
0.1	0.5	4	6	35	0.2	0.05	4.1	0.009756	0.509684	0.713922	0.171429	0.402197628	2.815383	0.452198
0.15	0.5	4	6	35	0.3	0.075	4.15	0.021687	0.339789	0.582915	0.171429	0.492526692	3.447687	0.567527
0.2	0.5	4	6	35	0.4	0.1	4.2	0.038095	0.254842	0.504819	0.171429	0.568648333	3.980538	0.668648
0.25	0.5	4	6	35	0.5	0.125	4.25	0.058824	0.203874	0.451524	0.171429	0.635687102	4.44981	0.760687
0.3	0.5	4	6	35	0.6	0.15	4.3	0.083721	0.169895	0.412183	0.171429	0.696271533	4.873901	0.846272
0.35	0.5	4	6	35	0.7	0.175	4.35	0.112644	0.145624	0.381607	0.171429	0.751963297	5.263743	0.926963
0.4	0.5	4	6	35	0.8	0.2	4.4	0.145455	0.127421	0.356961	0.171429	0.803780042	5.62646	1.00378

	i	v=0.5 m/s	v=0.3 m/s	v=1 m/s	v=0.7 m/s
L=30 m	0.066667	0.524116	1.134448	0.180387	0.313671
	0.1	0.617923	1.335519	0.214116	0.370613
	0.133333	0.706833	1.526789	0.245574	0.4243
	0.166667	0.795159	1.717191	0.276545	0.477478
L=25 m	0.08	0.562669	1.216958	0.194342	0.337125
	0.12	0.671515	1.450753	0.23312	0.402997
	0.16	0.777411	1.678909	0.270339	0.466802
	0.2	0.885308	1.911779	0.307964	0.531647
L=35 m	0.057143	0.495224	1.072778	0.169811	0.296029
	0.085714	0.578706	1.251337	0.200104	0.346857
	0.114286	0.656305	1.41803	0.227741	0.393814
	0.142857	0.732003	1.581016	0.254423	0.439467
	0.171429	0.807881	1.744638	0.280989	0.485128

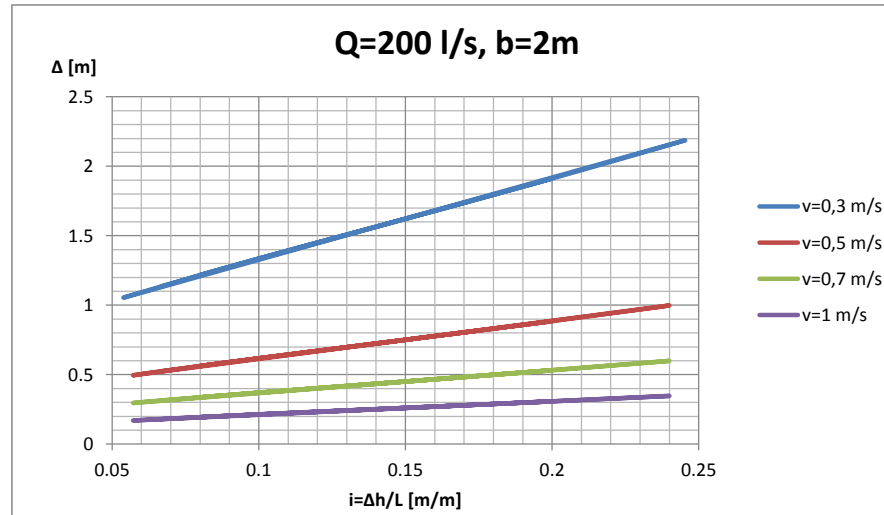

	i	b=2 m	b=2.5 m	b=3 m	b=3.5 m	b=4 m
L=30 m	0.066667	0.180387	0.160079	0.144944	0.133076	0.123426
	0.1	0.214116	0.190392	0.172752	0.158948	0.147748
	0.133333	0.245574	0.218535	0.198449	0.182744	0.170012
	0.166667	0.276545	0.24617	0.223614	0.205984	0.191696
L=25 m	0.08	0.194342	0.172644	0.156492	0.14384	0.133564
	0.12	0.23312	0.207404	0.188295	0.173351	0.161233
	0.16	0.270339	0.240637	0.218579	0.201338	0.187365
	0.2	0.307964	0.274155	0.249051	0.229431	0.213532
L=35 m	0.057143	0.169811	0.150527	0.136137	0.124839	0.115644
	0.085714	0.200104	0.177822	0.161242	0.148258	0.137717
	0.114286	0.227741	0.202592	0.183902	0.169284	0.157428
	0.142857	0.254423	0.226437	0.20565	0.1894	0.176227
	0.171429	0.280989	0.250131	0.227216	0.209307	0.194793

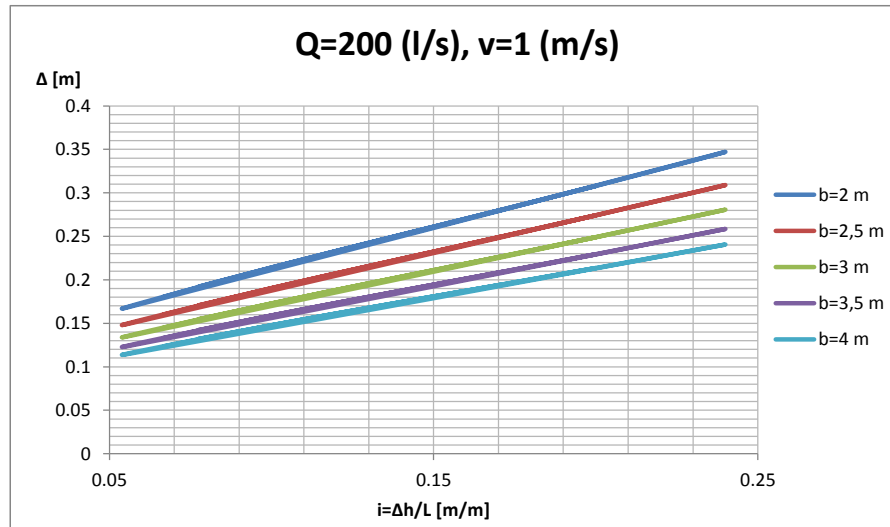

	i	Q=100 l/s	Q=150 l/s	Q=200 l/s	Q=250 l/s	Q=300 l/s	Q=350 l/s	Q=400 l/s
L=30 m	0.066667	0.12777	0.156353	0.180387	0.201507	0.220552	0.23802	0.254237
	0.1	0.151595	0.185548	0.214116	0.239237	0.261904	0.282709	0.302036
	0.133333	0.173838	0.212791	0.245574	0.274409	0.300434	0.324327	0.346529
	0.166667	0.195749	0.239619	0.276545	0.309026	0.338346	0.365266	0.390283
	0.2	0.217986	0.266841	0.307964	0.344138	0.376791	0.406773	0.434636
L=25 m	0.08	0.137623	0.168429	0.194342	0.21712	0.237667	0.25652	0.274029
	0.12	0.16503	0.202004	0.23312	0.260486	0.285183	0.307856	0.328922
	0.16	0.191358	0.234243	0.270339	0.30209	0.33075	0.357064	0.381518
	0.2	0.217986	0.266841	0.307964	0.344138	0.376791	0.406773	0.434636
	0.24	0.245729	0.300798	0.34715	0.387923	0.424727	0.458518	0.48992
L=35 m	0.057143	0.120308	0.147204	0.169811	0.18967	0.207571	0.223985	0.239216
	0.085714	0.141694	0.173417	0.200104	0.223566	0.244732	0.264155	0.282195
	0.114286	0.161227	0.197346	0.227741	0.254472	0.278595	0.30074	0.321314
	0.142857	0.180098	0.220455	0.254423	0.284301	0.311268	0.336027	0.359035
	0.171429	0.198894	0.243469	0.280989	0.313993	0.343785	0.371138	0.396558

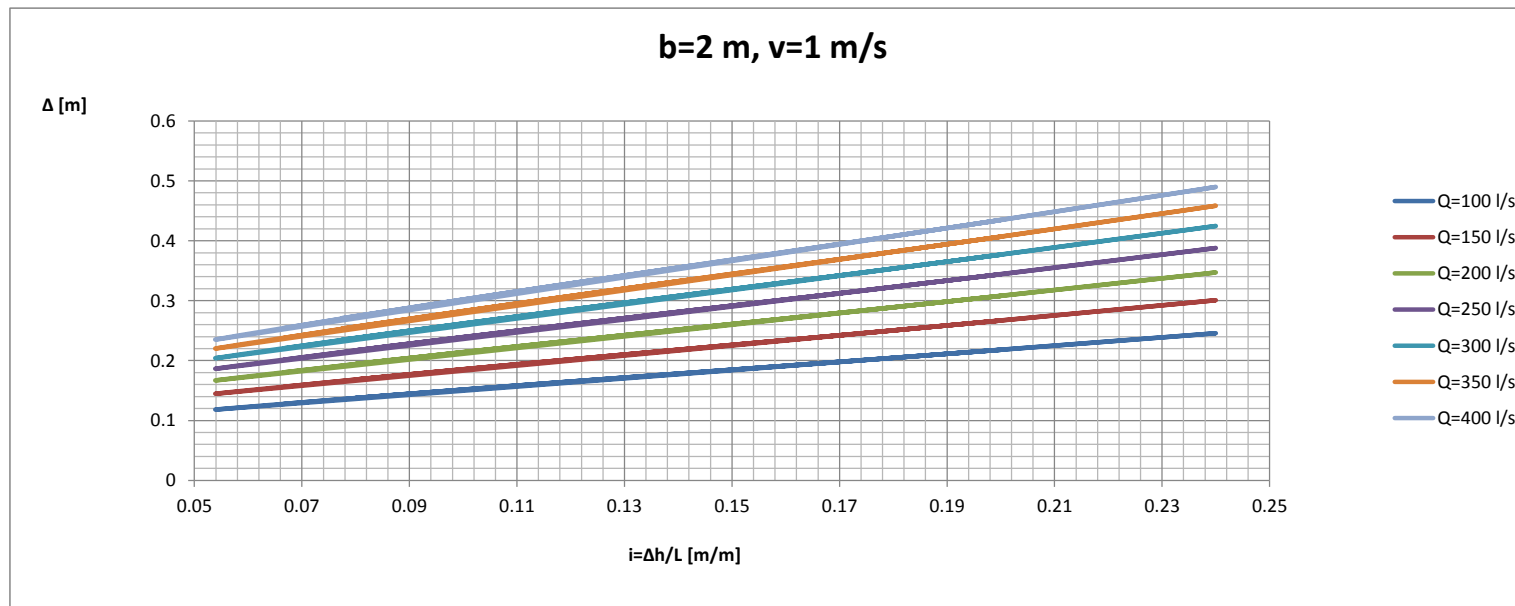

PRILOG 2

– PRORAČUNSKA SHEMA RIBLJIH STAZA SA BAZENIMA

ULAZNI PARAMETRI						
v (m/s)	E (W/m ³)	ψ	h _{min}	ΔH (m)	Q(m ³ /s)	b (m)
1	150	0.75	0.6	2	0.1	1
1	150	0.75	0.6	3	0.1	1
1	150	0.75	0.6	4	0.1	1
1	150	0.75	0.6	5	0.1	1
1	150	0.75	0.6	6	0.1	1

1	150	0.75	0.6	2	0.2	1
1	150	0.75	0.6	3	0.2	1
1	150	0.75	0.6	4	0.2	1
1	150	0.75	0.6	5	0.2	1
1	150	0.75	0.6	6	0.2	1

1	150	0.75	0.8	2	0.3	1
1	150	0.75	0.8	3	0.3	1
1	150	0.75	0.8	4	0.3	1
1	150	0.75	0.8	5	0.3	1
1	150	0.75	0.8	6	0.3	1

1	150	0.75	0.8	2	0.4	1
1	150	0.75	0.8	3	0.4	1
1	150	0.75	0.8	4	0.4	1
1	150	0.75	0.8	5	0.4	1
1	150	0.75	0.8	6	0.4	1

1	150	0.75	0.6	2	0.1	1.25
1	150	0.75	0.6	3	0.1	1.25
1	150	0.75	0.6	4	0.1	1.25
1	150	0.75	0.6	5	0.1	1.25
1	150	0.75	0.6	6	0.1	1.25

1	150	0.75	0.6	2	0.2	1.25
1	150	0.75	0.6	3	0.2	1.25
1	150	0.75	0.6	4	0.2	1.25
1	150	0.75	0.6	5	0.2	1.25
1	150	0.75	0.6	6	0.2	1.25

1	150	0.75	0.8	2	0.3	1.25
1	150	0.75	0.8	3	0.3	1.25
1	150	0.75	0.8	4	0.3	1.25

PRORAČUNATE VRIJEDNOSTI					
Δh (m)	n bazena $\frac{\Delta H}{\Delta h} - 1$	As (m ²) $\frac{Q}{\psi} \cdot v$	bs=hs (m) $\sqrt{A_s}$	l _b (m) $\frac{1000 \cdot 9.81 \cdot \Delta h \cdot Q}{b \cdot E \cdot h_{min}}$	L _{uk} (m) $n_{bazena} \cdot l_b$
0.05	39	0.133333	0.365148	0.545	21.255
0.05	59	0.133333	0.365148	0.545	32.155
0.05	79	0.133333	0.365148	0.545	43.055
0.05	99	0.133333	0.365148	0.545	53.955
0.05	119	0.133333	0.365148	0.545	64.855

0.05	39	0.266667	0.516398	1.09	42.51
0.05	59	0.266667	0.516398	1.09	64.31
0.05	79	0.266667	0.516398	1.09	86.11
0.05	99	0.266667	0.516398	1.09	107.91
0.05	119	0.266667	0.516398	1.09	129.71

0.05	39	0.4	0.632456	1.22625	47.82375
0.05	59	0.4	0.632456	1.22625	72.34875
0.05	79	0.4	0.632456	1.22625	96.87375
0.05	99	0.4	0.632456	1.22625	121.3988
0.05	119	0.4	0.632456	1.22625	145.9238

0.05	39	0.533333	0.730297	1.635	63.765
0.05	59	0.533333	0.730297	1.635	96.465
0.05	79	0.533333	0.730297	1.635	129.165
0.05	99	0.533333	0.730297	1.635	161.865
0.05	119	0.533333	0.730297	1.635	194.565

0.05	39	0.133333	0.365148	0.436	17.004
0.05	59	0.133333	0.365148	0.436	25.724
0.05	79	0.133333	0.365148	0.436	34.444
0.05	99	0.133333	0.365148	0.436	43.164
0.05	119	0.133333	0.365148	0.436	51.884

0.05	39	0.266667	0.516398	0.872	34.008
0.05	59	0.266667	0.516398	0.872	51.448
0.05	79	0.266667	0.516398	0.872	68.888
0.05	99	0.266667	0.516398	0.872	86.328
0.05	119	0.266667	0.516398	0.872	103.768

0.05	39	0.4	0.632456	0.981	38.259
0.05	59	0.4	0.632456	0.981	57.879
0.05	79	0.4	0.632456	0.981	77.499

ULAZNI PARAMETRI						
v (m/s)	E (W/m ³)	ψ	h _{min}	ΔH (m)	Q(m ³ /s)	b (m)
1	150	0.75	0.8	5	0.3	1.25
1	150	0.75	0.8	6	0.3	1.25

1	150	0.75	0.8	2	0.4	1.25
1	150	0.75	0.8	3	0.4	1.25
1	150	0.75	0.8	4	0.4	1.25
1	150	0.75	0.8	5	0.4	1.25
1	150	0.75	0.8	6	0.4	1.25

1	150	0.75	0.6	2	0.1	1.5
1	150	0.75	0.6	3	0.1	1.5
1	150	0.75	0.6	4	0.1	1.5
1	150	0.75	0.6	5	0.1	1.5
1	150	0.75	0.6	6	0.1	1.5

1	150	0.75	0.6	2	0.2	1.5
1	150	0.75	0.6	3	0.2	1.5
1	150	0.75	0.6	4	0.2	1.5
1	150	0.75	0.6	5	0.2	1.5
1	150	0.75	0.6	6	0.2	1.5

1	150	0.75	0.8	2	0.3	1.5
1	150	0.75	0.8	3	0.3	1.5
1	150	0.75	0.8	4	0.3	1.5
1	150	0.75	0.8	5	0.3	1.5
1	150	0.75	0.8	6	0.3	1.5

1	150	0.75	0.8	2	0.4	1.5
1	150	0.75	0.8	3	0.4	1.5
1	150	0.75	0.8	4	0.4	1.5
1	150	0.75	0.8	5	0.4	1.5
1	150	0.75	0.8	6	0.4	1.5

PRORAČUNATE VRIJEDNOSTI					
Δh (m)	n bazena $\frac{\Delta H}{\Delta h} - 1$	As (m ²) $\frac{Q}{\psi} \cdot v$	bs=hs (m) $\sqrt{A_s}$	l _b (m) $\frac{1000 \cdot 9.81 \cdot \Delta h \cdot Q}{b \cdot E \cdot h_{\min}}$	L _{uk} (m) $n_{bazena} \cdot l_b$
0.05	99	0.4	0.632456	0.981	97.119
0.05	119	0.4	0.632456	0.981	116.739

0.05	39	0.533333	0.730297	1.308	51.012
0.05	59	0.533333	0.730297	1.308	77.172
0.05	79	0.533333	0.730297	1.308	103.332
0.05	99	0.533333	0.730297	1.308	129.492
0.05	119	0.533333	0.730297	1.308	155.652

0.05	39	0.133333	0.365148	0.363333333	14.17
0.05	59	0.133333	0.365148	0.363333333	21.43667
0.05	79	0.133333	0.365148	0.363333333	28.70333
0.05	99	0.133333	0.365148	0.363333333	35.97
0.05	119	0.133333	0.365148	0.363333333	43.23667

0.05	39	0.266667	0.516398	0.726666667	28.34
0.05	59	0.266667	0.516398	0.726666667	42.87333
0.05	79	0.266667	0.516398	0.726666667	57.40667
0.05	99	0.266667	0.516398	0.726666667	71.94
0.05	119	0.266667	0.516398	0.726666667	86.47333

0.05	39	0.4	0.632456	0.8175	31.8825
0.05	59	0.4	0.632456	0.8175	48.2325
0.05	79	0.4	0.632456	0.8175	64.5825
0.05	99	0.4	0.632456	0.8175	80.9325
0.05	119	0.4	0.632456	0.8175	97.2825

0.05	39	0.533333	0.730297	1.09	42.51
0.05	59	0.533333	0.730297	1.09	64.31
0.05	79	0.533333	0.730297	1.09	86.11
0.05	99	0.533333	0.730297	1.09	107.91
0.05	119	0.533333	0.730297	1.09	129.71

Δh_{tot} (m)	Q=100 l/s	Q=200 l/s	Q=300 l/s	Q=400 l/s
2	21.255	42.51	47.82375	63.765
3	32.155	64.31	72.34875	96.465
4	43.055	86.11	96.87375	129.165
5	53.955	107.91	121.3988	161.865
6	64.855	129.71	145.9238	194.565

	l_{bazena} (m)
Q=100 l/s	0.545
Q=200 l/s	1.09
Q=300 l/s	1.22
Q=400 l/s	1.635

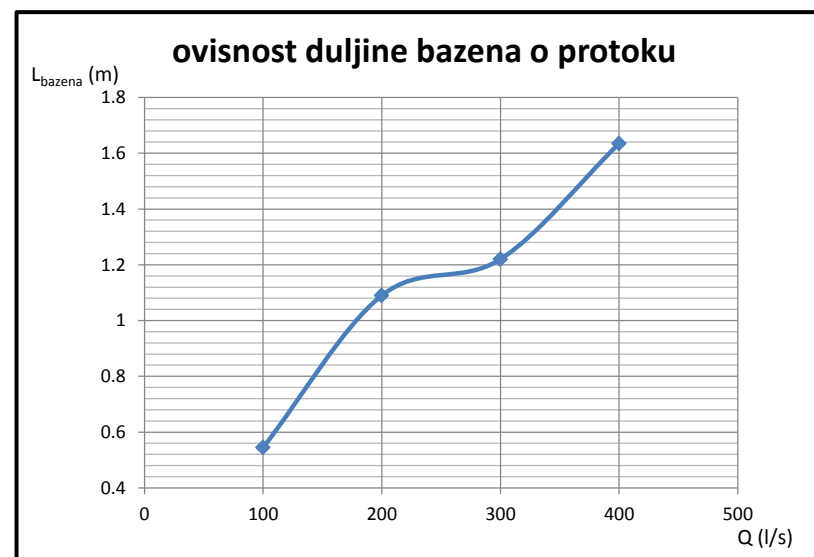
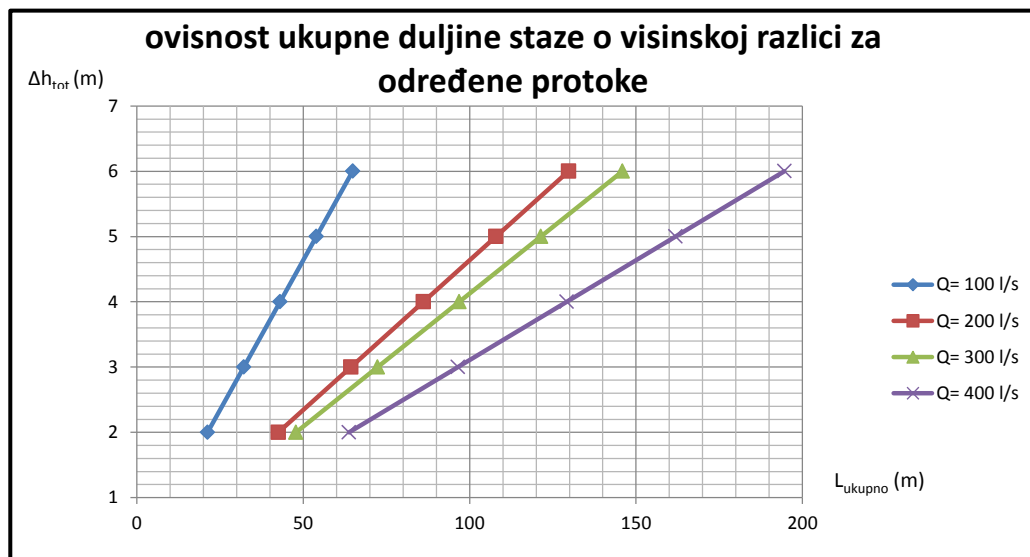

PRILOG 3

– PRORAČUNSKA SHEMA PRIRODNIH RIBLJIH STAZA

Q [m ³ /s]	h [m]	b [m]	A [m ²]	O [m]	R [m]	v [m/s]	I [1]	k _s [1]
0.4	0.3	2	0.735	3.081	0.2385	0.5442	0.02	0.15
0.4	0.3	2	0.735	3.081	0.2385	0.5442	0.018	0.15
0.4	0.3	2	0.735	3.081	0.2385	0.5442	0.016	0.15
0.4	0.3	2	0.735	3.081	0.2385	0.5442	0.014	0.15
0.4	0.3	2	0.735	3.081	0.2385	0.5442	0.0135	0.15

h _{pot} [m]	d [m]	a [m]	A _d [m ²]	A ₀ [m ²]	V _k [m ³]	A _x [m ²]	A _r [m ²]	n _k	n _{k,usv}	λ ₀ [1]	λ _k [1]	S _{Ad} [m ²]	Ω _r [m ²]	λ [1]	ε ₀ [1]	ε _v [1]	V [m/s]	Q [m ³ /s]
0.3	0.6	1	0.18	0.28	0.08	0.95	200.00	210.56	211	0.13	0.74	37.98	308.17	1.13	0.12	0.24	0.57	0.422
0.3	0.7	1.1	0.21	0.38	0.12	1.23	222.22	181.17	182	0.13	0.67	38.22	342.41	1.06	0.11	0.26	0.56	0.414
0.3	0.8	1.2	0.24	0.50	0.15	1.54	250.00	162.49	163	0.13	0.61	39.12	385.21	1.00	0.10	0.27	0.55	0.403
0.3	0.9	1.4	0.27	0.64	0.19	2.01	285.71	142.17	143	0.13	0.53	38.61	440.24	0.88	0.09	0.26	0.55	0.402
0.3	1	1.5	0.3	0.79	0.24	2.40	296.30	123.25	124	0.13	0.49	37.20	456.54	0.84	0.08	0.27	0.55	0.404

I [1]	ΔH [m]	L _R [m]
0.02	2	100
	3	150
	4	200
	5	250
	6	300

I [1]	ΔH [m]	L _R [m]
0.018	2	111.11
	3	166.67
	4	222.22
	5	277.78
	6	333.33

I [1]	ΔH [m]	L _R [m]
0.016	2	125.00
	3	187.50
	4	250.00
	5	312.50
	6	375.00

I [1]	ΔH [m]	L _R [m]
0.014	2	142.86
	3	214.29
	4	285.71
	5	357.14
	6	428.57

I [1]	ΔH [m]	L _R [m]
0.0135	2	148.15
	3	222.22
	4	296.30
	5	370.37
	6	444.44

Provjere:

Mirno tečenje

	V [m/s]	B [m]	A [m]	Fr	Fr < 1
1	0.57	2.9	0.735	0.13	
2	0.56	2.9	0.735	0.13	
3	0.55	2.9	0.735	0.12	
4	0.55	2.9	0.735	0.12	
5	0.55	2.9	0.735	0.12	

Brzina u suženim dijelovima

	B _s [m]	A _s [m]	V _s [m/s]
1	1.7	0.375	1.13
2	1.5	0.315	1.31
3	1.3	0.255	1.58
4	2.0	0.465	0.86
5	1.9	0.435	0.93

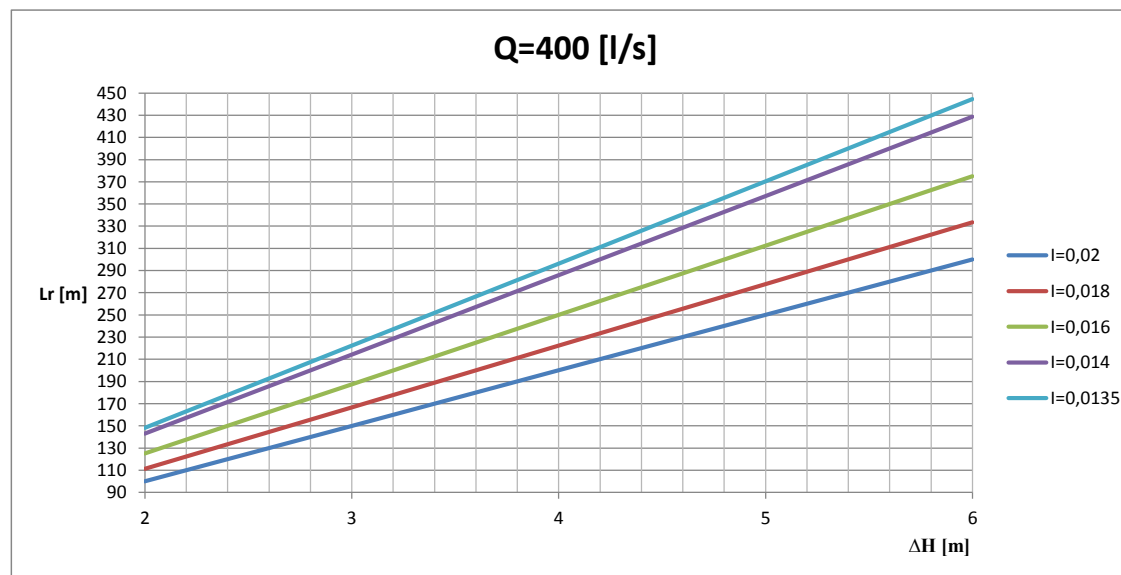

Froudov broj u suženim dijelovima

	V_s [m/s]	B_s [m]	A_s [m ²]	Fr	Fr<1.7
1	1.126	1.7	0.375	0.59	
2	1.314	1.5	0.315	0.84	
3	1.580	1.3	0.255	1.30	
4	0.864	2	0.465	0.33	
5	0.928	1.9	0.435	0.38	

h= 0.3m, b= 2 m, d= 0.6 m, a= 1m, $A_d=0.18m^2$, $A_o=0.28m^2$, $V_k=0.08m^3$, $A_x=0.95m^2$														
I [1]	ΔH [m]	L_R [m]	A_r [m ²]	n_k	$n_{k,usv}$	λ_0 [1]	λ_k [1]	S_{Ad} [m ²]	Ω_r [m ²]	λ [1]	ϵ_0 [1]	ϵ_v [1]	V [m/s]	Q [m ³ /s]
0.02	2	100	200.00	210.56	211	0.135	0.740	37.980	308.10	1.134	0.123	0.243	0.575	0.422
	3	150	300.00	315.84	316	0.135	0.738	56.880	462.15	1.132	0.123	0.243	0.575	0.423
	4	200	400.00	421.12	422	0.135	0.740	75.960	616.20	1.134	0.123	0.243	0.575	0.422
	5	250	500.00	526.40	527	0.135	0.739	94.860	770.25	1.132	0.123	0.243	0.575	0.423
	6	300	600.00	631.68	632	0.135	0.738	113.760	924.30	1.132	0.123	0.243	0.575	0.423

h= 0.3m, b= 2 m, d= 0.7 m, a= 1.1m, $A_d=0.21m^2$, $A_o=0.38m^2$, $V_k=0.12m^3$, $A_x=1.23m^2$														
I [1]	ΔH [m]	L_R [m]	A_r [m ²]	n_k	$n_{k,usv}$	λ_0 [1]	λ_k [1]	S_{Ad} [m ²]	Ω_r [m ²]	λ [1]	ϵ_0 [1]	ϵ_v [1]	V [m/s]	Q [m ³ /s]
0.02	2	100	200.00	163.06	164	0.13	0.67	34.44	308.10	1.06	0.11	0.26	0.59	0.436
	3	150	300.00	244.59	245	0.13	0.67	51.45	462.15	1.06	0.11	0.26	0.59	0.437
	4	200	400.00	326.11	327	0.13	0.67	68.67	616.20	1.06	0.11	0.26	0.59	0.437
	5	250	500.00	407.64	408	0.13	0.67	85.68	770.25	1.06	0.11	0.26	0.59	0.437
	6	300	600.00	489.17	490	0.13	0.67	102.90	924.30	1.06	0.11	0.26	0.59	0.437

h= 0.3m, b= 2 m, d= 0.8 m, a= 1.2m, $A_d=0.24m^2$, $A_o=0.50m^2$, $V_k=0.15m^3$, $A_x=1.54m^2$														
I [1]	ΔH [m]	L_R [m]	A_r [m ²]	n_k	$n_{k,usv}$	λ_0 [1]	λ_k [1]	S_{Ad} [m ²]	Ω_r [m ²]	λ [1]	ϵ_0 [1]	ϵ_v [1]	V [m/s]	Q [m ³ /s]
0.02	2	100	200.00	129.99	130	0.13	0.61	31.20	308.10	0.99	0.10	0.27	0.61	0.451
	3	150	300.00	194.98	195	0.13	0.61	46.80	462.15	0.99	0.10	0.27	0.61	0.451
	4	200	400.00	259.98	260	0.13	0.61	62.40	616.20	0.99	0.10	0.27	0.61	0.451
	5	250	500.00	324.97	325	0.13	0.61	78.00	770.25	0.99	0.10	0.27	0.61	0.451
	6	300	600.00	389.96	390	0.13	0.61	93.60	924.30	0.99	0.10	0.27	0.61	0.451

h= 0.3m, b= 2 m, d= 0.9 m, a= 1.4m, A _d =0.27m ² , A _o =0.64m ² , V _k =0.19m ³ , A _x =2.01m ²														
I [1]	ΔH [m]	L _R [m]	A _r [m ²]	n _k	n _{k,usv}	λ ₀ [1]	λ _k [1]	S _{Ad} [m ²]	Ω _r [m ²]	λ [1]	ε ₀ [1]	ε _v [1]	V [m/s]	Q [m ³ /s]
0.002	2	100	200.00	99.52	100	0.13	0.53	27.00	308.10	0.88	0.09	0.26	0.65	0.480
	3	150	300.00	149.28	150	0.13	0.53	40.50	462.15	0.88	0.09	0.26	0.65	0.480
	4	200	400.00	199.04	200	0.13	0.53	54.00	616.20	0.88	0.09	0.26	0.65	0.480
	5	250	500.00	248.81	249	0.13	0.52	67.23	770.25	0.87	0.09	0.26	0.66	0.482
	6	300	600.00	298.57	299	0.13	0.52	80.73	924.30	0.87	0.09	0.26	0.65	0.481

h= 0.3m, b= 2 m, d=1.0 m, a= 1.5m, A _d =0.30m ² , A _o =0.79m ² , V _k =0.24m ³ , A _x =2.40m ²														
I [1]	ΔH [m]	L _R [m]	A _r [m ²]	n _k	n _{k,usv}	λ ₀ [1]	λ _k [1]	S _{Ad} [m ²]	Ω _r [m ²]	λ [1]	ε ₀ [1]	ε _v [1]	V [m/s]	Q [m ³ /s]
0.002	2	100	200.00	83.19	84	0.13	0.49	25.20	308.10	0.84	0.08	0.27	0.67	0.490
	3	150	300.00	124.79	125	0.13	0.49	37.50	462.15	0.83	0.08	0.27	0.67	0.493
	4	200	400.00	166.39	167	0.13	0.49	50.10	616.20	0.84	0.08	0.27	0.67	0.492
	5	250	500.00	207.98	208	0.13	0.49	62.40	770.25	0.83	0.08	0.27	0.67	0.493
	6	300	600.00	249.58	250	0.13	0.49	75.00	924.30	0.83	0.08	0.27	0.67	0.493

